



HOW TO ASSEMBLE

PATIO COVER SHADE

Compatible with Palram - Canopia's
10' / 3m Patio Cover Series

IMPORTANT!

Please read these instructions carefully before starting assembly.
Keep these instructions in a safe place for future reference.

www.canopia.com



A member of
Palram Industries Ltd.

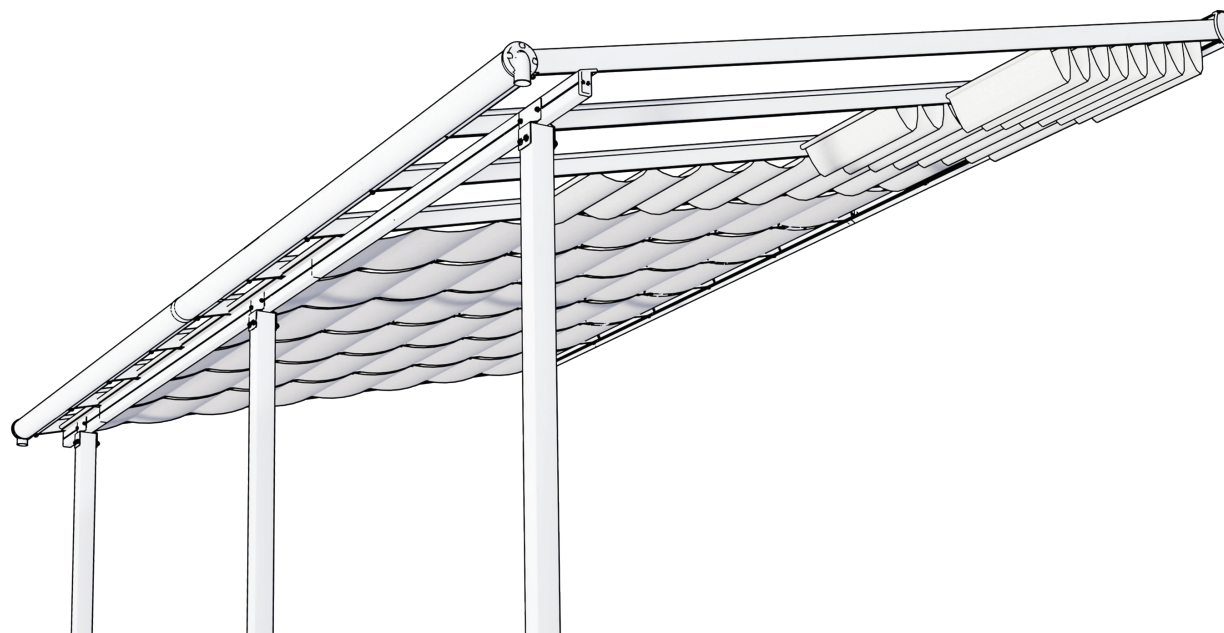



AVAILABLE MODELS

10x10 / 3x3

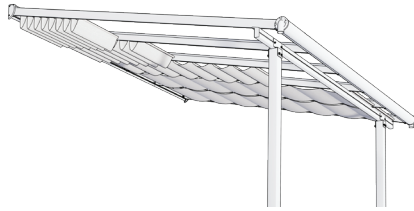

5 PC SET

1 BOX



10x14 / 3x4.3

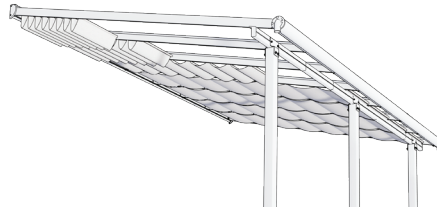

7 PC SET

1 BOX



10x18 / 3x5.6

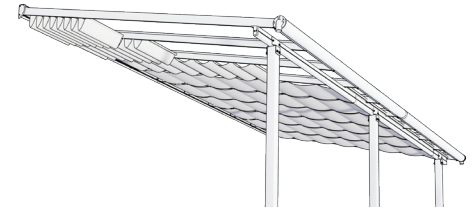

9 PC SET

1 BOX



10x20 / 3x6

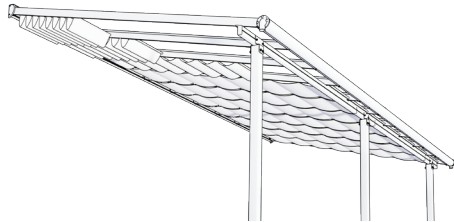

10 PC SET

2 BOXES



10x24 / 3x7.3

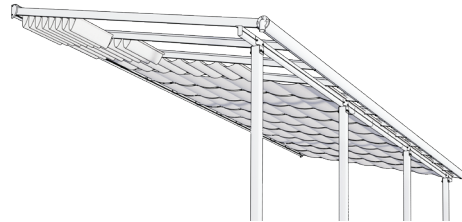

12 PC SET

2 BOXES



10x24 / 3x8.5

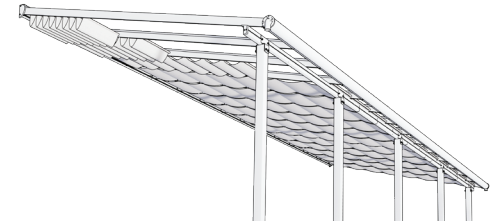

14 PC SET

2 BOXES



10x30 / 3x9.2



15 PC SET

3 BOXES



10x32 / 3x9.7



16 PC SET

2 BOXES



10x34 / 3x10.3



17 PC SET

3 BOXES





1

PARTS REQUEST

In the case of missing or damaged parts, do not return product to store.

Go to the link below or scan the QR code for help, it will direct you to a form that will help us assist you as soon as possible.



SCAN ME

Contact us on our website:
bit.ly/3js7yZi

2

ASSEMBLY ASSISTANCE

If you need any technical assistance in assembling your product, go to the link below or scan the QR code for help. It will direct you to a form that will help us assist you as soon as possible.



SCAN ME

Contact us on our website:
bit.ly/3kqqFEc



CUSTOMER SUPPORT



SCAN ME

WE ARE HERE TO HELP

For general questions: bit.ly/3kY07dP

USA



877-627-8476



hobbyservice@poly-tex.com

CANADA



905-5646007



sales@footprintproducts.com

UNITED KINGDOM · IRELAND



01302-380775



customer.serviceUK@palram.com

GERMANY



0180-522-8778



customer.serviceDE@palram.com

FRANCE · BELGIUM



+33-169-791-094



customer.serviceFR@palram.com

ISRAEL



04-848-6816



info.il@palram.co.il

ITALY · NETHERLANDS · PORTUGAL · SPAIN



+33-169-791-094



customer.serviceFR@palram.com

AUSTRIA · LUXEMBURG · LIECHTENSTEIN



+49-180-522-8778



customer.serviceDE@palram.com

AUSTRALIA



03-9219-4444



salesvic@palram.com

NORWAY · SWEDEN · ARGENTINA · GREECE · GREENLAND · ICELAND · ESTONIA · JAPAN · LATVIA · LITHUANIA
MAURITIUS · MEXICO · ROMANIA · RUSSIA · TURKEY · UZBEKISTAN · UKRAINE · SWAZILAND · KOREA



+972-4-848-6816



customer.service@palram.com



CUSTOMER SUPPORT



SCAN ME

WE ARE HERE TO HELP

For general questions: bit.ly/3kY07dP

AUSTRALIA - GREENHOUSES

 03-9544-6-999

 info@mazedistribution.com.au

HUNGARY · SLOVAKIA

 +420-493-523-523

 servis@garland.cz

NEW ZEALAND

 0800 800 880

 customer.service@palram.com

DENMARK

 07-575 42 70

 post@nshnordic.com

SOUTH AFRICA

 011-397-7771

 receptionza@palram.com

CROATIA · SLOVENIA

 0599-37-057

 info@ms-viscom.com

CZECH REPUBLIC

 0493-523-523

 servis@garland.cz

FINLAND

 Neuvonta: 09-6866720
Tuki / Varaosat: 050-3715350

 www.horisontenterprises.fi
tuki@horisontenterprises.fi

POLAND

 Infolinia: 801-011-929
22-349-93-36

 kontakt@ogrodosfera.pl

CYPRUS

 0224-971-13

 alpaco@alpacodomica.com
www.alpacodomica.com

SWITZERLAND

 062-287-33-77

 info@ritter.ch

SAFETY ADVICE

- Dispose of all plastic bags safely – keep them away from children’s reach.
- Keep children away from the assembly area.
- When using a stepladder or power tools, make sure that you are following the manufacturer’s safety advice.

CARE & MAINTENANCE

- Machine wash cold. No chlorine bleach. Line dry.

IMPORTANT RECOMMENDATIONS

- These instructions are compatible with Palaro-Canopia’s 3m depth (10’) Patio Cover Series.
- Please carry out the steps in the order set out in these instructions.
- Keep these instructions in a safe place for future reference.

TOOLS & EQUIPMENT



□ Ladder

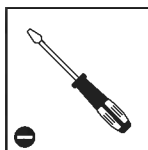

□ Flat Head Screwdriver

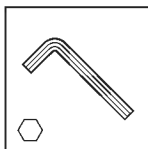

□ Allen Key

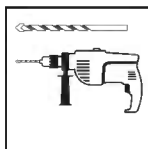

□ Electric drill - Drill bit
4 mm | 7/32”

IMPORTANT ASSEMBLY STEPS



When encountering this information icon during assembly, please refer to the relevant assembly step for important additional comments.

These instructions refer to the assembly of one (1) piece of the Patio Cover Shade set. Repeat these steps based on your Patio Cover size.

Step 1: Drill a hole up to 4mm in diameter on back of frame.

Step 2: Drill a hole up to 4mm in diameter on front of frame.

Step 6: Turn the screw 3-4 times only, see **drawing b**.

Step 7: Pull the cable while tightening and locking **part #9435**, see **drawing c**.

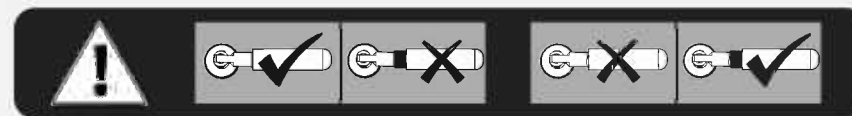

CONSEILS DE SECURITE

- Jetez précautionneusement tous les sacs plastiques – tenez-les hors de portée des enfants.
- Tenez les enfants à distance de la zone de montage.
- Si vous utilisez un escabeau ou des outils électriques, assurez-vous de respecter les consignes de sécurité du fabricant.

ENTRETIEN & MAINTENANCE

- Lavage en machine à froid. Aucun agent de blanchiment au chlore. Ligne sèche.

RECOMMANDATIONS IMPORTANTES

- Ces instructions sont compatibles avec la série de couvertures de patio Palram-Canopia de 3 m de profondeur (10').
- Veuillez lire attentivement ces instructions avant de débiter le montage du produit.
- Veuillez suivre les étapes dans l'ordre indiqué dans ces instructions.
- Conservez ces instructions en lieu sûr pour référence ultérieure.

OUTILS ET ÉQUIPEMENT



Echelle

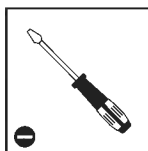

Tournevis plat

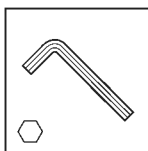

Clé Allen

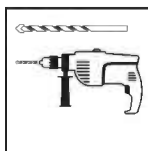

Perceuse filaire avec foret 4 mm | 7/32"

PRINCIPALES ÉTAPES D'ASSEMBLAGE



Lorsque vous rencontrez cette icône d'information pendant l'assemblage, veuillez vous référer à l'étape d'assemblage correspondante pour d'autres commentaires importants.

Ces instructions se réfèrent à l'assemblage d'une (1) partie de l'ensemble de l'abri de terrasse. Répétez ces étapes en fonction de la taille de votre abri de terrasse.

Étape 1:

Percez un trou de 4 mm de diamètre à l'arrière du cadre.

Étape 2:

Percez un trou de 4 mm de diamètre à l'avant du cadre.

Étape 6:

Tourner la vis 3-4 fois seulement, voir **dessin b.**

Étape 7:

Tirez le câble tout en serrant et en verrouillant la pièce# 9435, voir **dessin c.**

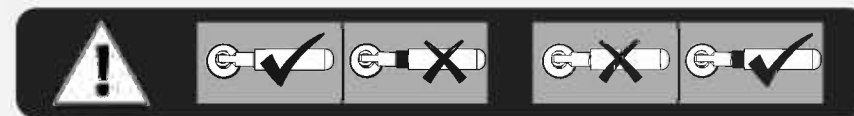

SICHERHEITSHINWEISE

- Entsorgen Sie die Plastikbeutel vorschriftsgemäss – und achten Sie darauf, dass sie nicht in Reichweite von Kindern kommen.
- Halten Sie Kinder während des Aufbaus vom Carport fern.
- Wenn Sie eine Stufenleiter oder Elektrowerkzeuge benutzen, achten Sie darauf, die Sicherheitshinweise des Herstellers zu befolgen.

PFLEGE & WARTUNG

- Kalt in der Waschmaschine waschen Keine Chlorbleiche. Auf der Wäscheleine trocknen

WICHTIGE HINWEISE

- Diese Anweisungen sind mit der 3m tiefen (10') Patio-Abdeckungsserie von Palram-Canopia kompatibel.
- Bitte lesen Sie diese Anleitung aufmerksam durch, bevor Sie mit der Montage dieses Produktes beginnen.
- Bitte führen Sie die einzelnen Schritte in der in dieser Anleitung angegebenen Reihenfolge durch.
- Bewahren Sie diese Anleitung für späteren Gebrauch sicher auf.

WERKZEUGE & AUSTRÜSTUNG



Leiter

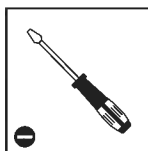

Schlitzschraubendreher

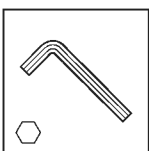

Inbusschlüssel /
Sechskantschlüssel

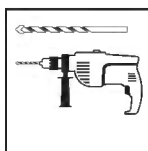

Bohrmaschine mit Bohrer
4 mm | 7/32"

WICHTIGE MONTAGESCHRITTE



Wenn Sie bei der Montage auf dieses Informationssymbol stoßen, finden Sie im jeweiligen Montageschritt wichtige Zusatzhinweise.

**Diese Anleitung bezieht sich auf die Montage von einem (1) Stück des Terrassenüberdachungs-Sets.
Wiederholen Sie diese Schritte entsprechend der Größe Ihrer Terrassenüberdachung.**

Schritt 1: Bohren Sie auf der Rückseite des Rahmens ein Loch mit einem Durchmesser von maximal 4 mm.

Schritt 2: Bohren Sie an der Vorderseite des Rahmens ein Loch mit einem Durchmesser von maximal 4 mm.

Schritt 6: Drehen Sie die Schraube nur 3 - 4 Mal, siehe **Zeichnung b**.

Schritt 7: Ziehen Sie das Kabel, während Sie **Teil Nr. 9435** festziehen und verriegeln, siehe **Zeichnung c**.

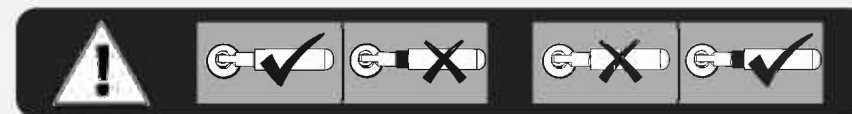

CONSEJOS DE SEGURIDAD

- Tire todas las bolsas de plástico con seguridad; manténgalas fuera del alcance de los niños pequeños.
- Mantenga a los niños lejos del área de montaje.
- Cuando utilice una escalera de mano o herramientas eléctricas, asegúrese de seguir los consejos de seguridad del fabricante.

CUIDADOS & MANTENIMIENTO

- Lave a máquina con agua fría. No use cloro. Línea seca. Cuelgue para que se seque.

RECOMENDACIONES IMPORTANTES

- Estas instrucciones son compatibles con la serie de cubiertas para patio de 3 m de profundidad (10') de Palram-Canopia.
- Le rogamos lea con atención las siguientes instrucciones antes de empezar a montar este producto.
- Siga los distintos pasos en el mismo orden de las instrucciones.
- Guarde las instrucciones en un lugar seguro para poder consultarlas en el futuro.

HERRAMIENTAS Y EQUIPOS



□ Escalera

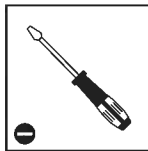

□ Destornillador de cabeza plana

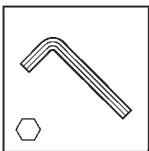

□ Llave Allen / Llave hexagonal

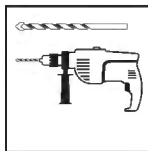

□ Taladro eléctrico con broca o mecha 4 mm | 7/32"

PASOS DE MONTAJE IMPORTANTES



Al encontrar este icono de información durante el montaje, consulte el paso de montaje correspondiente para obtener importantes comentarios adicionales.

Estas instrucciones corresponden al montaje de una (1) pieza del juego de toldos para patios. Repita estos pasos en función del tamaño de su toldo.

Paso 1:

Realice un orificio de hasta 4 mm de diámetro en la parte posterior del marco.

Paso 2:

Realice un orificio de hasta 4 mm de diámetro en la parte delantera del marco.

Paso 6:

Gire el tornillo solamente de 3 a 4 veces, vea la **figura b**.

Paso 7:

Tire del cable mientras aprieta y bloquea la **pieza #9435**, vea la **figura c**.

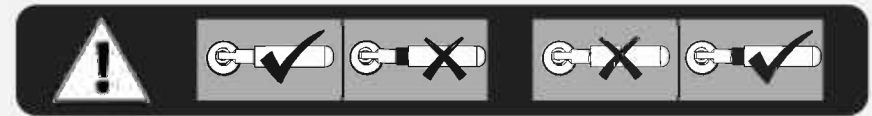

שלבים חשובים בהרכבה

כאשר אתם רואים את הסמל הזה במהלך ההרכבה, אנא פנו אל שלב ההרכבה לקבלת הערות חשובות נוספות.

הוראות אלה מתייחסות להרכבת חלק אחד (1) מתוך סט וילונות לפרגולה. לחזור על השלבים בהתאם לגודל סט וילונות לפרגולה שברשותך.



שלב 1: קדחו חור עד קוטר 4 מ"מ בפרופיל אחורי.

שלב 2: קדחו חור עד קוטר 4 מ"מ בפרופיל הקדמי.

שלב 6: סובב את הבורג 3-4 פעמים בלבד, ראה ציור ב'.

שלב 7: משוך את הכבל תוך הידוק וחסימה של חלק מס' 9435, ראה ציור ג'.



הצעת בטיחות

- נא להיפטר בבטחה משקיות הפלסטיק שבאריזה - להרחיק מהישג ידם של פעוטות.
- נא להרחיק ילדים קטנים מאזור ההתקנה.
- בשימוש בסולם או כל כלי עבודה חשמלי יש לעקוב אחר הוראות הבטיחות של היצרן.

טיפול ותחזוקה

- במכונת כביסה - שטיפה קרה. ללא כלור. ייבוש בתליה.

המלצות חשובות

- הוראות אלה תואמות לסדרת פרגולות, עומק 3 מטר (10') של פלרם מבית CANOPIA.
- נא לקרוא בקפידה את הוראות ההרכבה לפני תחילת הרכבת המוצר.
- נא לבצע את שלבי ההרכבה בסדר המוצג בהוראות אלה.
- נא לשמור את הוראות ההרכבה במקום בטוח לשימוש עתידי.

כלים וציוד

מברג רגיל

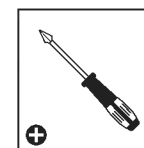

סולם

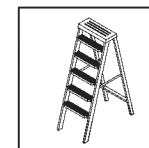

מקדחה חשמלית
כולל מקדחים
4mm | 7/32

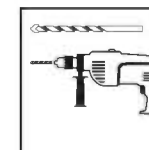

מפתח אלן

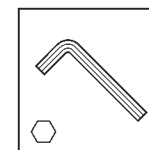

SÄKERHETSÅD

- Gör dig av med alla plastpåsar på ett säkert sätt – håll dem borta från barn.
- Håll barnen borta från monteringsområdet.
- När du använder en stege eller motordrivna verktyg, säkerställ att du följer tillverkarens säkerhetsråd.

RENGÖRINGSINSTRUKTIONER

- Maskintvättas kallt. Ej klorinblekning. Hängtorkas.

VIKTIGA REKOMMENDATIONER

- Dessa instruktioner är kompatibla med Palram-Canopias 3 m djup (10') Patio Cover Series.
- Var vänlig läs instruktionerna noggrant innan du börjar montera produkten.
- Vänligen utför instruktionerna enligt de steg som angivits i dessa instruktioner.
- Spara dessa instruktioner på ett säkert ställe för framtida referens.

VERKTYG OCH REDSKAP



Stege

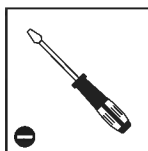

Spårmejsel

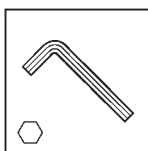

Bracon-nyckel

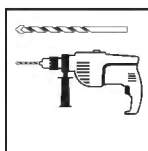

Elektrisk borrar med borrar 4 mm | 7/32"

VIKTIGA MONTERINGSSTEG



När du ser denna ikon under montering, se relevant monteringssteg för viktiga ytterligare kommentarer.

Dessa instruktioner avser montering av en (1) del av terrassolskyddet. Upprepa dessa steg baserat på storleken på ditt terrassolskydd.

Steg 1:

Borra ett hål upp till 4 mm i diameter på baksidan av ramen.

Steg 2:

Borra ett hål upp till 4 mm i diameter på framsidan av ramen.

Steg 6:

Vrid skruven endast 3- 4 gånger, se **ritning b**.

Steg 7:

Dra kabeln medan del #9435 spänns och låses, se **ritning c**.

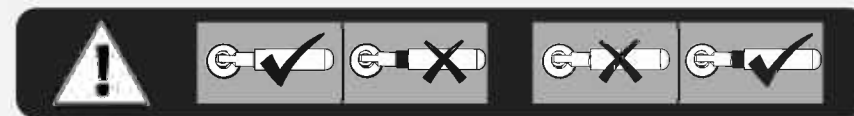

SIKKERHETSÅD

- Kvitt deg med all plastposer, på en trygg måte – hold dem borte i fra barns rekkevidde.
- Hold barn borte fra monteringsområdet.
- Sikre at du følger produsentens sikkerhetsråd når du bruker stige eller elektroverktøy.

RENGÖRINGSINSTRUKTIONER

- Kald maskinvask. Ingen blekemidler med klør. Henges opp til tork.

VIKTIGA REKOMMENDATIONER

- Disse instruksjonene er kompatible med Palram-Canopias 3 m-dybde (10') Patio Cover Series.
- Les instruksjonene nøye før du begynner på monteringen av dette produktet.
- Følg stegene som forklart i instruksjonen.
- Oppbevar denne instruksjonen på et trygt sted, for fremtidig referanse.

VERKTÖY OG UTSTYR



Stige

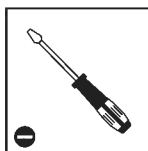

Flat skrutrekker

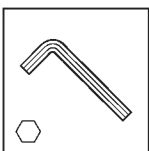

Brakonøkkel

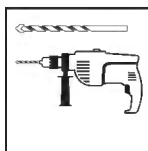

Elektrisk drill med bor 4 mm | 7/32"

TÄRKEÄT ASENNUSVAIHEET



Kun näet tämän tietokuvakkeen asennuksen aikana, katso tärkeät lisähuomautukset olennaisesta asennusvaiheesta.

Disse instruksjonene refererer til installasjon av en (1) del av terrassen solbeskyttelse. Gjenta disse trinnene basert på størrelsen på terrassesolskjermen.

Trinn 1:

Bor et hull på opptil 4 mm i diameter på baksiden av rammen.

Trinn 2:

Bor et hull opp til 4 mm i diameter på forsiden av rammen.

Trinn 6:

Drei bare skruen 3- 4 ganger, se beskrivelse på **tegning b**.

Trinn 7:

Trekk i kabelen mens du strammer og låser delen # 9435, se **tegning c**.

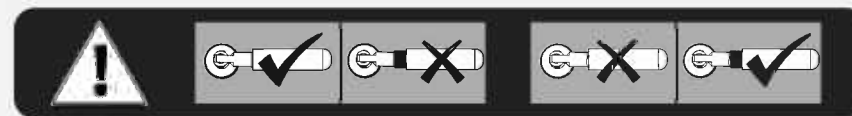

TURVALLISUUSOHJEET

- Hävitä kaikki muovisuojat huolella - älä jätä niitä lasten ulottuville.
- Pidä lapset poissa asennuspaikalta.
- Kun käytät tikkaita tai sähkötyökaluja noudata aina valmistajan antamia turva- ja käyttöohjeita.

PUHDISTUSOHJEET

- Kylmä konepesu. Ei klooria sisältävää valkaisuainetta. Narukuivaus.

TÄRKEITÄ SUOSITUKSIA

- Nämä ohjeet ovat yhteensopivia Palram-Canopiain 3 metrin syvyyden (10') patiopelisarjan kanssa.
- Lue nämä ohjeet huolellisesti ennen kuin aloitat tämän tuote kokoonpanon.
- Suorita vaiheet järjestyksellisesti esitettyjen ohjeitten mukaisesti.
- Tallenna nämä ohjeet myöhempää käyttöä varten.

TYÖKALUT & VÄLINEET



Tikkaat

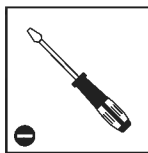

Talttapäinen ruuvimeisseli

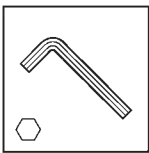

Kuusiokoloavain / Kuusiokulma-avain

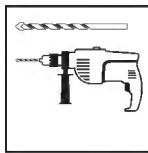

Sähköporakone poranterällä 4 mm | 7/32"

VIKTIGE MONTERINGSTRINN



Når du ser dette ikonet under montering, vennligst se relevant monteringstrinn for viktige tilleggskommentarer.

Nämä ohjeet koskevat yhden (1) Patio Cover Shade -sarjan osan kokoamista. Toista nämä vaiheet Patio Cover -tuotteittesi määrän mukaan.

Trinn 1:

Poraa läpimitaltaan enintään 4 mm reikä kehyksen takapuolelle.

Trinn 2:

Poraa läpimitaltaan enintään 4 mm reikä kehyksen etupuolelle.

Trinn 6:

Kierrä ruuvia vain 3- 4 kertaa, katso **piirustus b.**

Trinn 7:

Vedä kaapeli samalla kiristäen ja lukiten osan **#9435**, katso **piirustus c.**

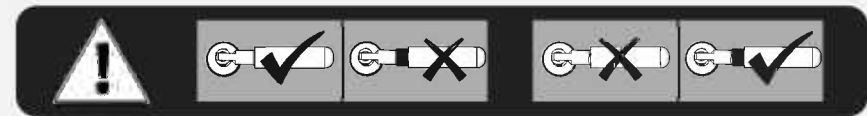

SIKKERHEDSRÅD

- Bortskaf alle plastikposer på sikker vis - hold dem uden for børns rækkevidde væk.
- Hold børn væk fra monteringsområdet.
- Når du anvender en trappestige, eller elektriske værktøjer, så vær sikker på at du følger producentens sikkerhedsanvisninger.

RENGØRINGSVEJLEDNING

- Vaskemaskine koldt. Ingen klorin. Linjen er tør.

VIKTIGE ANBEFALINGER

- Denne vejledning er kompatibel med Palram-Cannopia's 3 m dybde (10') Patio Cover Series.
- Læs venligst vejledningen omhyggeligt, inden du begynder at montere dette produkt.
- Udfør venligst trinene i den rækkefølge de er angivet i vejledningen.
- Opbevar denne vejledning et sikkert sted for fremtidig reference.

VÆRKTØJ & Udstyr



Stige

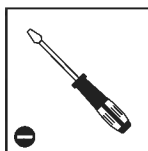

Flad
Skruetrækker

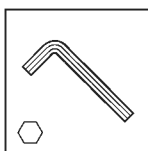

Unbrakonøgle

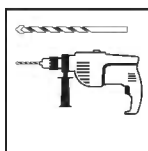

Elektrisk boremaskine med
bor 4 mm | 7/32"

VIGTIGE MONTERINGSTRIN



Når du støder på dette informationsikon under monteringen, se det relevante monteringstrin for vigtige yderligere kommentarer.

Denne vejledning henviser til samlingen af et (1) stykke af terrassedækslet. Gentag disse trin baseret på din Patio Cover-størrelse.

Trin 1:

Bor et hul op til 4 mm i diameter på bagsiden af rammen.

Trin 2:

Bor et hul op til 4 mm i diameter foran rammen.

Trin 6:

drej kun skruen 3- 4 gange, se **tegning b.**

Trin 7:

Træk kablet ud under stramning og låsning af del #9435, se **tegning c.**

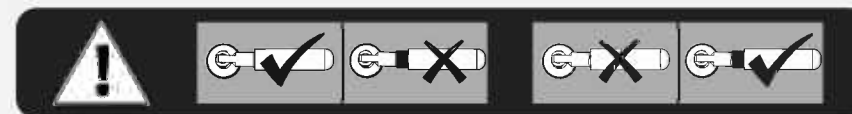

VEILIGHEIDSADVIES

- Verwijder de plastic verpakking veilig en houdt deze buiten bereik van kinderen.
- Laat kinderen niet in de buurt van tijdens de opbouw.
- Bij het gebruik van trapladders of elektrisch gereedschap hanteer dan altijd de bijbehorende veiligheidsinstructies.

SCHOONMAAK INSTRUCTIES

- Koud in de machine wassen. Geen chloorbleekmiddel. Aan de lijn drogen.

BELANGRIJKE AANBEVELINGEN

- Deze instructies zijn compatibel met de Patio Cover-serie van 3 m diepte (10').
- Alstublieft lees deze handleiding voor u begint met het assembleren van het product.
- Alstublieft volg de stappen in de volgorde zoals vermeld staat in deze instructie.
- Bewaar deze instructies op een goede plek.

GEREEDSCHAP & UITRUSTING



☐ Ladder

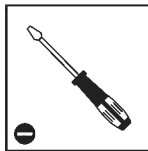

☐ Schroevendraaier met Platte Kop

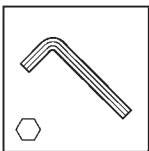

☐ Inbussleutel /
Zeshoekige Sleutel

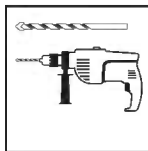

☐ Elektrische Boor Met
Boorbeitel 4 mm | 7/32"

BELANGRIJKE STAPPEN VAN DE OPBOUW



Wanneer u dit informatiepictogram tijdens de opbouw tegenkomt, raadpleeg dan de betreffende stap van de opbouw voor belangrijke bijkomende opmerkingen.

Deze instructies hebben betrekking op de montage van één (1) stuk van de Patio Cover Shade-set. Herhaal deze stappen op basis van de afmetingen van uw Patio Cover.

Stap 1:

Boor een gat met een diameter van max. 4 mm in de achterkant van het frame.

Stap 2:

Boor een gat met een diameter van max. 4 mm in de voorkant van het frame.

Stap 6:

Draai de schroef slechts 3- 4 keer, zie **tekening b**.

Stap 7:

Trek aan de kabel tijdens het vastdraaien en vergrendelen van onderdeel #9435, zie **tekening c**.

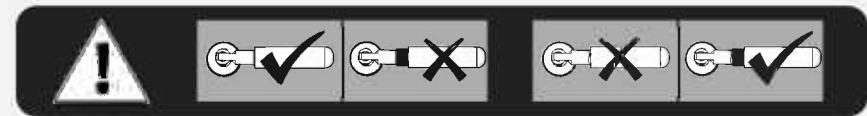

CONSIGLIO DI SICUREZZA

- Smaltire tutti i sacchetti di plastica in modo sicuro - tenerli lontani dalla portata dei bambini.
- Tenere i bambini lontani dalla zona di assemblaggio.
- Quando utilizzate una scala o strumenti di potenza, assicuratevi di seguire i consigli di prudenza del produttore.

ISTRUZIONI PER LA PULIZIA

- Lavaggio in lavatrice a freddo. Senza sbiancante al cloro. Asciugatura naturale.

RACCOMANDAZIONI IMPORTANTI

- Queste istruzioni sono compatibili con la serie di coperture per patio di 3 m di profondità (10') di Palram-Canopia.
- Si prega di leggere attentamente le istruzioni prima di iniziare a montare questo prodotto.
- Si prega di andare passo passo nell'ordine indicato in queste istruzioni.
- Conservare le istruzioni in un luogo sicuro per un futuro riferimento.

STRUMENTI E ATTREZZATURE



☐ Scala

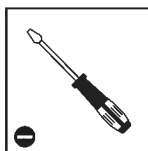

☐ Cacciavite a testa piatta

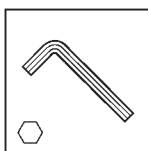

☐ Chiave a brugola /
Chiave esagonale

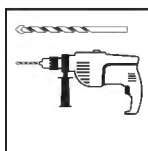

☐ Trapano elettrico con punta
di trapano 4 mm | 7/32"

FASI DI MONTAGGIO IMPORTANTI



Quando si incontra questa icona informativa durante il montaggio, fare riferimento alla relativa fase di montaggio per ulteriori importanti commenti.

Queste istruzioni sono per il montaggio di un (1) pezzo del kit tenda da sole per il patio. Ripetete questi passi a seconda delle dimensioni della vostra tenda da sole.

Passo 1: Praticare un foro di 4 mm di diametro nella parte posteriore del telaio.

Passo 2: Praticare un foro di 4 mm di diametro nella parte anteriore del telaio.

Passo 6: Girare la vite solo 3 - 4 volte, vedi **disegno b.**

Passo 7: Tirare il cavo durante il serraggio e il bloccaggio della **parte 9435, vedi disegno c.**

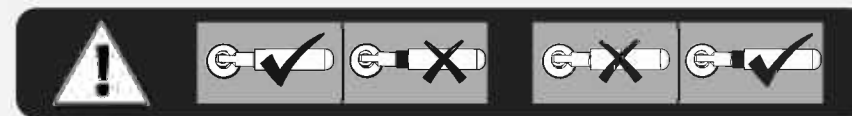

BEZPEČNOSTNÁ RADA

- Bezpečne odstráňte všetky plastové obaly – udržiajte ich mimo dosahu malých detí.
- Udržujte deti mimo oblasti montáže.
- Pri používaní schodkového rebríka alebo elektrického náradia sa ubezpečte, že nasledujete bezpečnostné pokyny výrobcu.

POKYNY NA ČISTENIE

- Perte v práčke v studenej vode. Bez chlórového bielidla. Sušte na vzduchu.

DÔLEŽITÉ ODPORÚČANIA

- Tieto pokyny sú kompatibilné so sádou Patio Cover Series o hĺbke 3 m (10').
- Pred začatím montáže tohto výrobku si, prosím, dôkladne prečítajte tieto pokyny.
- Skôr, než začnete s montážou výrobku, si dôkladne prečítajte tieto pokyny.
- Kroky vykonávajte v poradí uvedenom v týchto pokynoch. Pokyny si odložte na bezpečné miesto, aby ste ich mohli v budúcnosti znova použiť.

NÁSTROJE A ZARIADENIE



☐ Rebrík

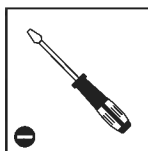

☐ Skrutkovač s plochou hlavou

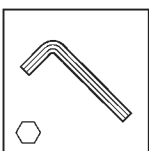

☐ Imbusový kľúč /
šesťhranný kľúč

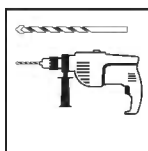

☐ Elektrická vŕtačka
s vrtákom 4 mm | 7/32"

DÔLEŽITÉ MONTÁŽNE KROKY



Keď sa počas montáže stretnete s touto informačnou ikonou, ďalšie dôležité poznámky nájdete v príslušnom montážnom kroku.

Tento návod sa týka montáže jedného (1) kusu sady Patio Cover Shade (Zastrešenie terasy). Tieto kroky zopakujte podľa veľkosti zastrešenia terasy.

Krok 1: Na zadnej strane rámu vyvŕtajte otvor s priemerom až 4 mm.

Krok 2: Do prednej časti rámu vyvŕtajte otvor s priemerom až 4 mm.

Krok 6: Skrutku otočte iba 3 - 4 krát, pozri **nákres b.**

Krok 7: Potiahnite kábel pri ťahovaní a uzamykaní časti #9435 pozri **nákres c.**

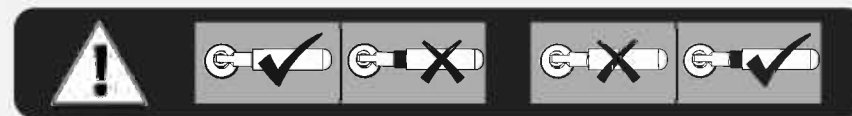

VARNOSTNI NAPOTEK

- Varno odstranite vse plastične vrečke - hranite jih izven dosega majhnih otrok.
- Otroke držite stran od območja za sestavljanje.
- Pri uporabi lestve ali električnih orodij se prepričajte, da upoštevate varnostne nasvete proizvajalca.

NAVODILA ZA ČIŠČENJE

- Hladno strojno pranje. Brez belila s klorom. Sušenje na zraku.

POMEMBNA PRIPOROČILA

- Ta navodila so združljiva s Palram-Canopia ovo 3 m globino (10') Patio Cover Series.
- Pazljivo preberite ta navodila, preden začnete sestavljati ta izdelek.
- Izvedite korake v zaporedju, kot je navedeno v teh navodilih.
- Ta navodila shranite na varnem mestu za kasnejšo uporabo.

ORODJA & OPREMA



Lestev

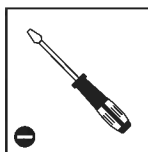

Izvijajč s ploščato glavo

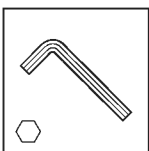

Allen ključ /
šesterokotni ključ

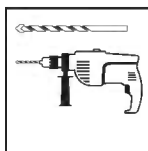

Električni vrtalnik
s svedom 4 mm | 7/32"

POMEMBNI KORAKI MONTAŽE



Če med montiranjem naletite na to ikono za informacije, glejte ustrezni korak montaže za pomembne dodatne opombe.

Ta navodila se nanašajo na sestavo enega (1) kosa kompleta senčil za pokrivala za teraso. Te korake ponovite glede na velikost pokrivala za teraso.

Korak 1: Na zadnji strani okvirja izvrtajte luknjo s premerom do 4 mm.

Korak 2: Na sprednji strani okvirja izvrtajte luknjo s premerom do 4 mm.

Korak 6: Vijak privijte samo 3 - 4 krat, glejte **sliko b.**

Korak 7: Med zategovanjem in zaklepanjem dela #9435 povlecite kabel, glejte **sliko c.**

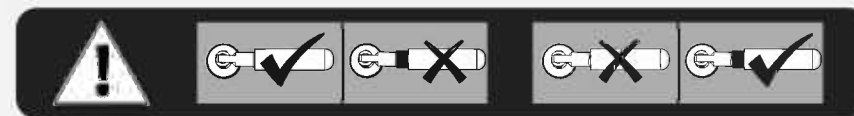

OHUTUSNÕUDED

- Vabanege kõigist plastikkottides turvaliselt - vältige nende sattumist väikeste laste käeulatusse.
- Vältige laste sattumist eseme kokkupanemisalale.
- Kasutades treppredelit või elektrilisi tööriistu, veenduge, et järgite tootja ohutusjuhiseid.

PUHASTUSJUHISED

- Külüm masinapesu. Kloorivalgendit mitte kasutada. Riputada kuivama.

OLULISED SOOVITUSED

- Need juhised ühilduvad Palrami-Canopia 3meetrise (10') siseõuekatete sarjaga.
- Palun tutvuge käesolevate juhistega põhjalikult enne seda, kui alustate selle toote kokkupanemist.
- Palun teostage nimetatud sammud käesolevates juhistes mainitud järjekorras.
- Palun hoidke käesolevad juhised turvalises kohas alles, et tulevikus neid kasutada.

TÖÖRIISTAD JA SEADMED



Redel

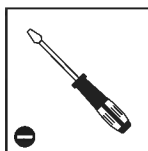

Lapik kruvikeeraja

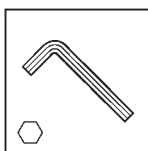

Kuuskantvõti

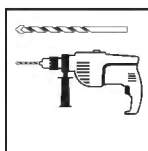

Elektriline puur puuriteraga
4 mm | 7/32"

OLULISED KOKKUPANEMISSAMMUD



Kui näete kokkupanemisel seda teabeikooni, palun vaadake vastavat kokkupanemisetappi oluliste lisakommentaariume saamiseks.

Käesolevad juhised viitavad Terrassi kattevarju komplekti ühe (1) osa kokkupanekule. Korrake neid samme vastavalt oma Terrassi katte suurusele.

Samm 1: Puurige auk läbimõõduga kuni 4 mm raami tagaküljel.

Samm 2: Puurige auk läbimõõduga kuni 4 mm raami esiküljel.

Samm 6: Keerake kruvi ainult 3 - 4 korda, vaadake **joonist b.**

Samm 7: Tõmmake kaablit osa #9435 pingutamise ja lukustamise ajal, vaadake **joonist c.**

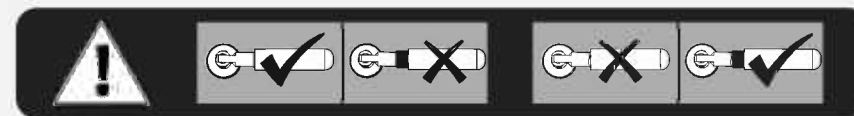

BIZTONSÁGI TANÁCSOK

- Az összes műanyag zacskót óvatosan távolítsa el - tartsa ezeket távol a kisgyermekektől.
- Tartsa távol a gyermekeket az összeszerelési területtől.
- Ha létrát, vagy elektromos kéziszerszámokat használ, ügyeljen arra, hogy mindig kövesse azon gyártók biztonsági előírásait.

TISZTÍTÁSI ÚTMUTATÓ

- Mosógépben hideg vízzel kell mosni. Tilos fehérítőt alkalmazni. Szárítókötélen szárítsa.

FONTOS AJÁNLÁSOK

- Ezek az utasítások összeegyeztethetők a Palram-Canopia 3 méteres (10') teraszfedél-sorozatával.
- A termék összeállítása előtt kérjük, olvassa át alaposan ezeket az utasításokat.
- A lépéseket az útmutatónak megfelelő sorrendben végezze el.
- Tartsa meg ezt az útmutatót egy biztonságos helyen, hogy később is használhassa.

SZERSZÁMOK ÉS KÉSZÜLÉKEK



☐ Létra

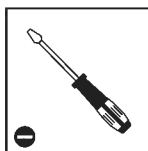

☐ Laposfejű csavarhúzó

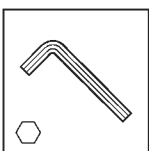

☐ Imbuszkulcs

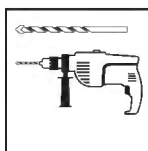

☐ Elektromos fúró, fúrószárral
4 mm | 7/32"

FONTOS ÖSSZESZERELÉSI LÉPÉSEK



Amikor összeszerelés során ezzel az információs ikonnal találkozik, úgy kérjük, olvassa el a vonatkozó összeszerelési lépést a további fontos megjegyzésekkel kapcsolatban.

Ezek az utasítások a teraszárnyékoló készlet egy (1) darabjának összeszerelésére vonatkoznak. Ismétlje meg ezeket a lépéseket a teraszárnyékoló mérete függvényében.

1. lépés:

Fúrjon egy legfeljebb 4 mm átmérőjű lyukat a keret hátoldalán.

2. lépés:

Fúrjon egy legfeljebb 4 mm átmérőjű lyukat a keret elülső oldalán.

6. lépés:

csak 3 - 4 fordulatot forgasson a csavaron, lásd a **b. ábra**.

7. lépés:

Húzza meg a kábelt, s miközben húzza, rögzítse a **9435 sz.** elemet, lásd a **c. ábra**.

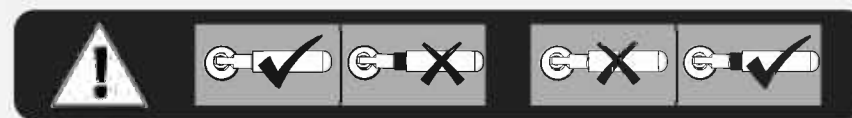

RADY DOT. BEZPIECZEŃSTWA

- Należy w bezpieczny sposób usunąć wszystkie plastikowe torby - trzymać je poza zasięgiem dzieci.
- Trzymaj dzieci z dala od miejsca wykonywania montażu.
- Podczas korzystania z drabiny lub elektronarzędzi, upewnij się, że postępujesz zgodnie z zaleceniami bezpieczeństwa producenta.

INSTRUKCJE CZYSZCZENIA

- Prać w pralce w zimnej wodzie. Nie stosować wybielaczy chlorowych. Suszyć w stanie rozwieszonym.

WAŻNE ZALECENIA

- Te instrukcje są zgodne z serią okładek patio Palram-Canopia o głębokości 3 m (10').
- Przed przystąpieniem do montażu produktu prosimy o uważne zapoznanie się z instrukcją oraz o przeprowadzanie poszczególnych etapów montażu w kolejności określonej w niniejszej instrukcji.
- Zachowaj tę instrukcję w bezpiecznym miejscu do przyszłego użytku.

NARZĘDZIA I SPRZĘT



□ Drabina

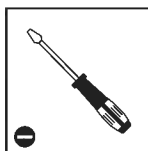

□ Śrubokręt Płaski

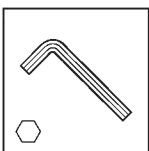

□ Klucz Imbusowy

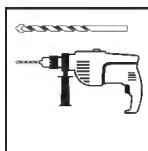

□ Wiertarka Elektryczna z Wiertłem 4 mm | 7/32"

WAŻNE KROKI MONTAŻU



Kiedy napotkasz taką ikonę informacyjną w trakcie montażu, prosimy zapoznać się z odpowiednim krokiem montażu opatrzonym ważnym komentarzem dodatkowym.

Instrukcje odnoszą się do montażu jednego (1) elementu zestawu osłony przeciwsłonecznej na taras. Kroki należy powtarzać w zależności od rozmiaru osłony.

Krok 1:

Wywiercić otwór o średnicy do 4 mm na tylnej części ramy.

Krok 2:

Wywiercić otwór o średnicy do 4 mm na przedniej części ramy.

Krok 6:

Przekręcić śrubę tylko 3 - 4 razy, zobacz **rysunek b.**

Krok 7:

Pociągnąć kabel podczas dokręcania i blokowania części #9435, patrz **rysunek c.**

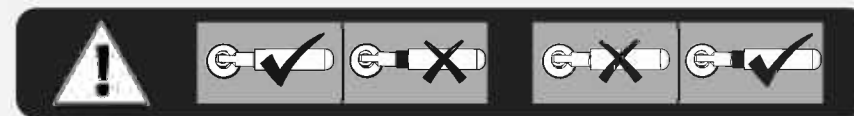

РЕКОМЕНДАЦИЯ ПО ТЕХНИКЕ БЕЗОПАСНОСТИ

- Утилизируйте все пластиковые пакеты безопасно, держите их в недоступном для детей месте.
- Держите детей подальше от места сборки.
- При использовании стремянки или электроинструмента убедитесь в том, что вы следуете рекомендациям по безопасности.

ИНСТРУКЦИИ ПО УБОРКЕ

- Машинная стирка холодной водой. Не используйте хлорный отбеливатель. Высушите, повесив на шнуре.

ВАЖНЫЕ РЕКОМЕНДАЦИИ

- Эти инструкции совместимы с серией обложек Patio глубиной 3 м (10').
- Пожалуйста, внимательно прочитайте эту инструкцию, прежде чем приступить к сборке этого продукта.
- Выполняйте шаги в рекомендуемом порядке, указанном в этой инструкции.
- Храните эту инструкцию в надежном месте для дальнейшего использования.

ИНСТРУМЕНТЫ И ОБОРУДОВАНИЕ



☐ Стремянка

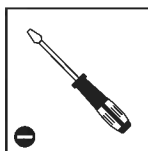

☐ Отвертка с плоским шлицем

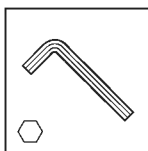

☐ Шестигранный шлиц

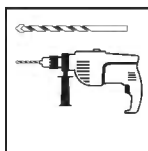

☐ Электрическая дрель с перовым сверлом 4 мм | 7/32"

ВАЖНЫЕ ЭТАПЫ СБОРКИ



Если во время сборки вам встречается такая справочная иконка, необходимо обратиться к соответствующему этапу сборки для ознакомления с дополнительными важными замечаниями.

Данная инструкция относится к сборке одного (1) элемента комплекта «Навес для патио». Повторите эти шаги в зависимости от размера вашего навеса для патио.

Шаг 1: Просверлите отверстие диаметром до 4 мм на задней части рамы.

Шаг 2: Просверлите отверстие диаметром до 4 мм на передней части рамы.

Шаг 6: Поверните винт только 3 - 4 раза, см. **Рисунок В.**

Шаг 7: Потяните за кабель, одновременно затягивая и фиксируя деталь #9435, см. **Рисунок С.**

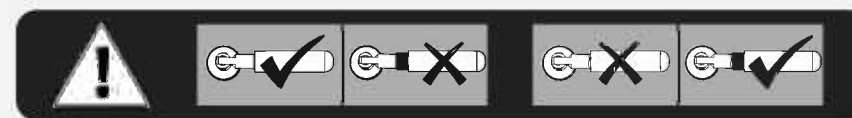

DROŠĪBAS PADOMI

- Izmetiet visus plastmasas maisus drošā vietā - uzglabājot tos maziem bērniem nepieejamā vietā.
- Turiet bērnus pēc iespējas tālāk no montāžas vietas.
- Lietojot saliekamās kāpnes vai elektroinstrumentus, pārliecinieties, ka sekojat ražotāja norādījumiem par drošību.

TĪRĪŠANAS NORĀDĪJUMI

- Mazgāt veļas mazgājamā mašīnā ar aukstu ūdeni. Bez hlora balinātāja. Žāvēt, izkarot.

SVARĪGI IETEIKUMI

- Šīs instrukcijas ir saderīgas ar Palram-Canopia 3 m dziļuma (10') terašu segumu sēriju.
- Lūdzu, pirms šī produkta uzstādīšanas, rūpīgi izlasiet šos norādījumus.
- Lūdzu, veiciet darbības šajos norādījumos norādītajā kārtībā.
- Noglabājiet šos norādījumus drošā vietā, lai varētu tos izmantot arī vēlāk.

RĪKI UN APRĪKOJUMS



Kāpnes

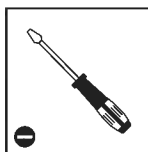

Plakanas galvas skrūvgriezis

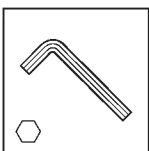

Sešstūra atslēga

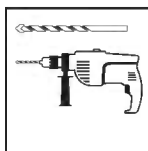

Elektriskā urbja mašīna ar urbi 4 mm | 7/32"

SVARĪGAS DARBĪBAS MONTĀŽAI



Saskaroties ar šo informācijas ikonu montāžas laikā, lūdzu, skatiet attiecīgo montāžas darbību, lai iegūtu svarīgus papildu komentārus.

Šie norādījumi ir paredzēti viena (1) Patio Canopy Kit komplekta salikšanai. Atkārtojiet šīs darbības atkarībā no patio patversmes lieluma.

Solis 1: Rāmja aizmugurē urbiet caurumu līdz 4 mm diametrā.

Solis 2: Rāmja priekšpusē urbiet caurumu līdz 4 mm diametrā.

Solis 6: Grieziet skrūvi tikai 3 – 4 reizes, sk. **Zīmējumu b.**

Solis 7: Pavelciet kabeli, pievelkot un nofiksējot detaļu # 9435, skat. **C zīmējumu.**

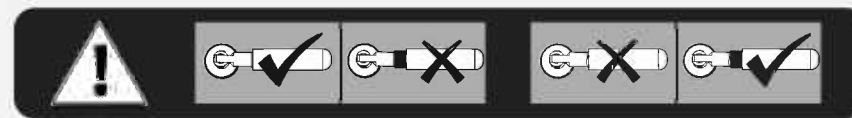

BEZPEČNOSTNÍ RADA

- Všechny plastové sáčky nebo tašky odkládejte bezpečná místa – přechovávejte je mimo dosah dětí.
- Nepouštějte děti na montážní pracoviště.
- Budete-li používat žebřík nebo nástroje s mechanickým pohonem, zajistěte, abyste postupovali podle bezpečnostních doporučení výrobce.

NÁVOD K ČIŠTĚNÍ

- Hladno strojno pranje. Bez izbjeljivača na bazi klora. Linija suha.

DŮLEŽITÁ DOPORUČENÍ

- Tyto instrukce jsou kompatibilní s řadou Patio Cover hloubky 3m (10') Palram-Canopia.
- Než zahájíte montáž tohoto produktu, přečtěte si prosím pozorně tento návod.
- Všechny kroky prosím proveďte v pořadí uvedeném v tomto návodu.
- Tento návod si uschovejte na bezpečném místě pro budoucí potřebu.

NÁSTROJE A ZAŘÍZENÍ



☐ Žebřík

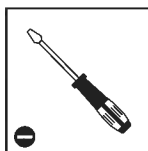

☐ Šroubovák s plochou hlavou

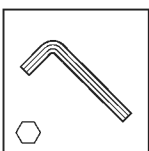

☐ Imbusový klíč / šestihranný klíč

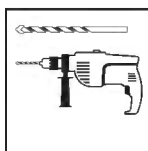

☐ Elektrická vrtačka s vrtákem 4 mm | 7/32"

DŮLEŽITÉ MONTÁŽNÍ KROKY



Když se během montáže setkáte s touto informační ikonou, další důležité poznámky najdete v příslušném montážním kroku.

Tyto pokyny se týkají montáže jednoho (1) kusu sady Patio Cover Shade. Opakujte tyto kroky na základě velikosti krytu vaší terasy.

Krok 1: Na zadní straně rámu vyvrtejte otvor o průměru až 4 mm.

Krok 2: Na přední straně rámu vyvrtejte otvor o průměru až 4 mm.

Krok 6: Vijak okrenite samo 3 - 4 puta, pogledajte **sliku b.**

Krok 7: Povucite kabel dok zatežete i zaključavate dio # 9435, pogledajte **sliku c.**

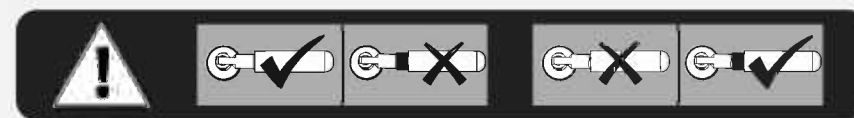

Curtain_shade

By Eran

Assembly Instructions

R&D Version

master_Curtain_shade_V1.3

25 August 2021 2:45 PM

וילון הצללה 1.3:
הוספת חלק 9437 לתכולה (לא בשימוש)
סידור ה"ה בתכולה (9501)

נחמיה

15/10/2020

הערות לשלבים:

שלב 1 - יש לקדוח חור בקוטר של עד 4mm

שלב 2 - יש לקדוח חור בקוטר של עד 4mm

שלב 6 - בתמונה (d) יש לסגור 3-4 כריכות בלבד

שלב 7 - בתמונה c יש למתוח את הכבל ותוך כדי הידוקה נועלן

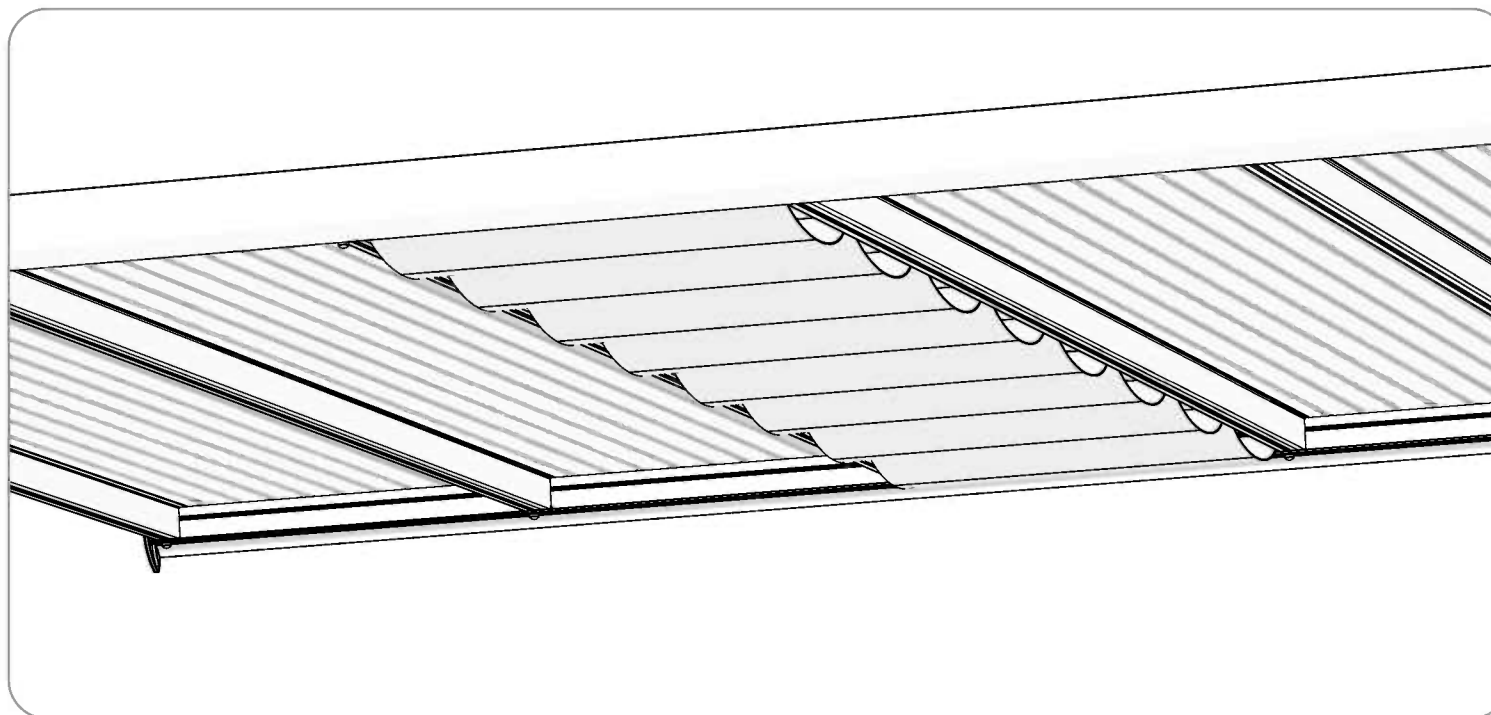

ההוראה מתייחס להרכבת ווילון 1 מתוך סט ווילונות ע"פ גודל המוצר

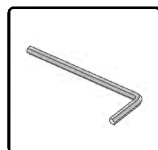
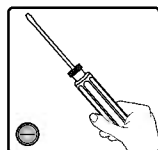
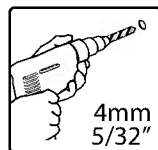



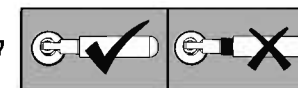

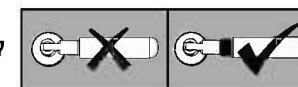

לסגור את המותחן

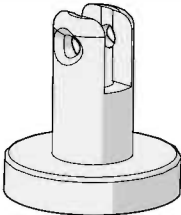
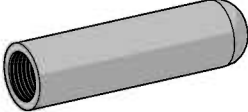
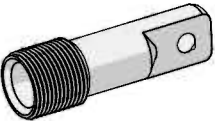
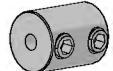

לא לסגור את המותחן

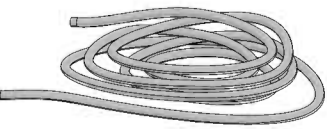

Contents

Item	ONE SET	Qty.
9434		4
9436		2
9449		2
9435		4
9433		4
9501		2
9439		2
9438		1
9441		16
9440		2

	product Size	Curtain Set	Metal Rod	Stencil
705868	*Ext. 1.8M	3 pcs		1
705869	3.05M	5 pcs	1	1
705870	4.25M	7 pcs	1	1
705871	5.46M	9 pcs	1	1

*Applicable only for Fiesta & Carnival Patio Cover Series

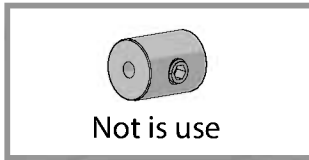

Stencil

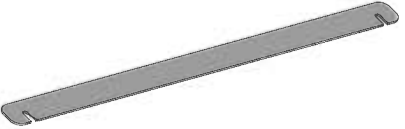
9461		1
------	--	---

Metal ROD

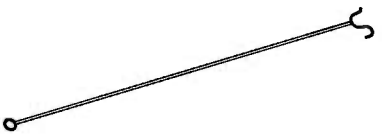
9442		1
------	--	---



Drill a hole up to 4mm in diameter on back of frame

1

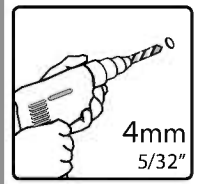
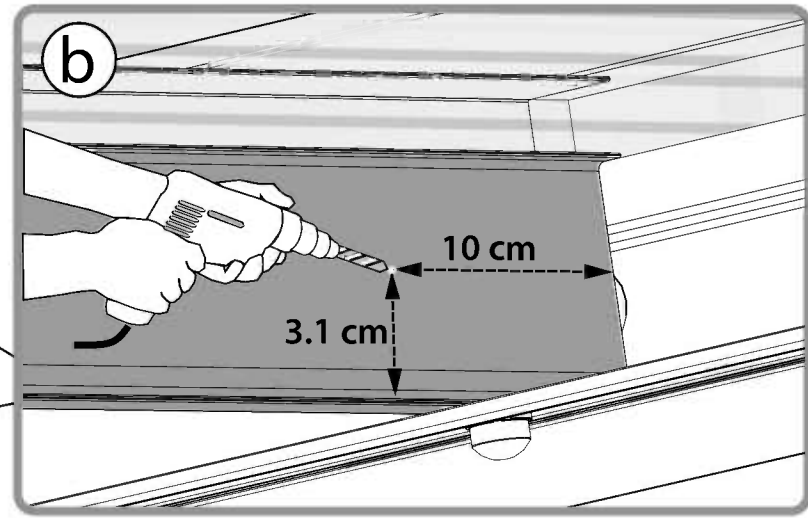
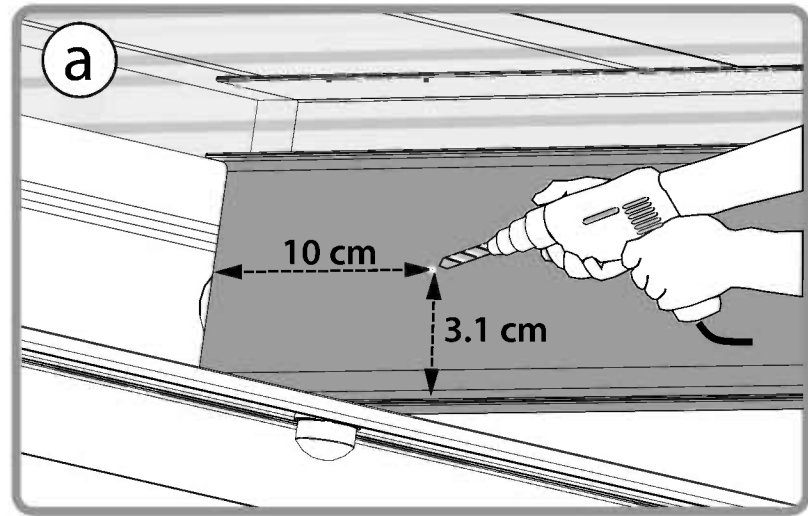
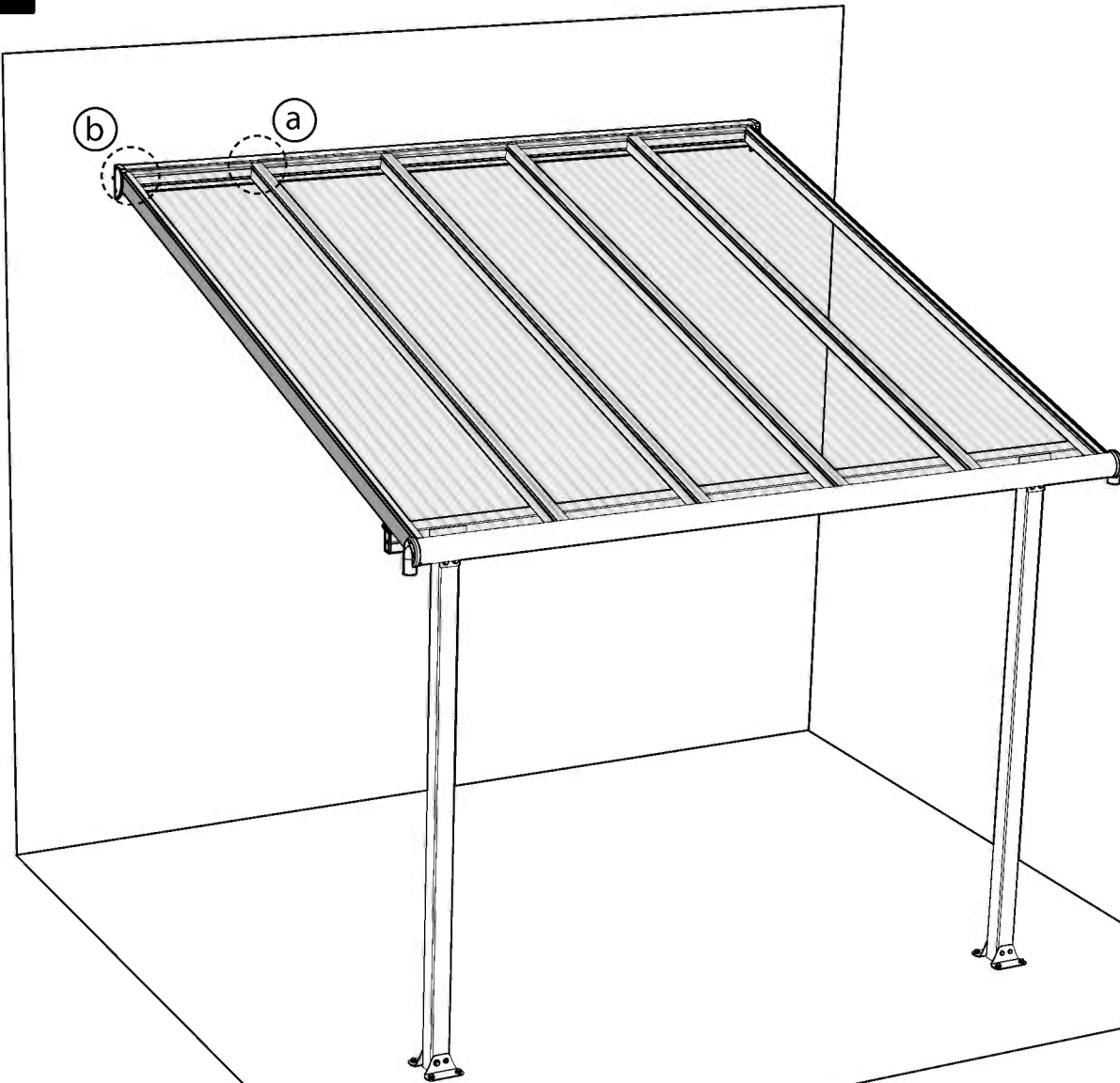



Drill a hole up to 4mm in diameter on front of frame

2

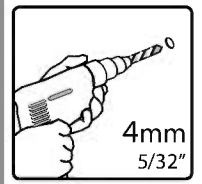
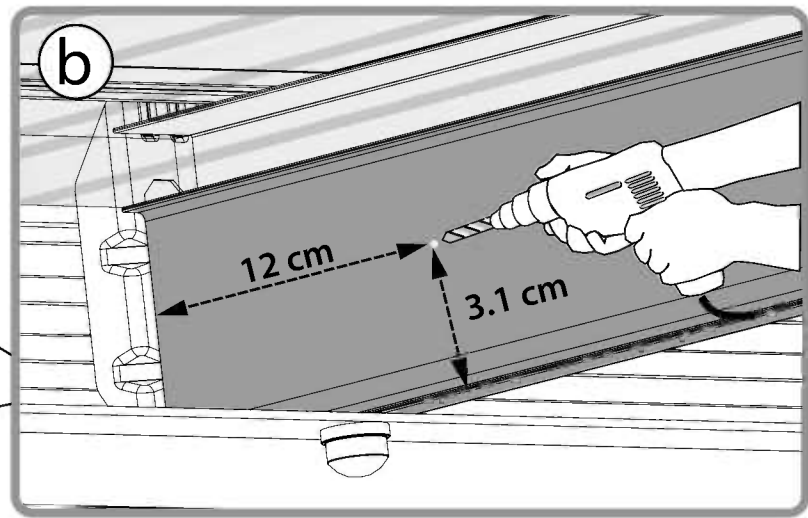
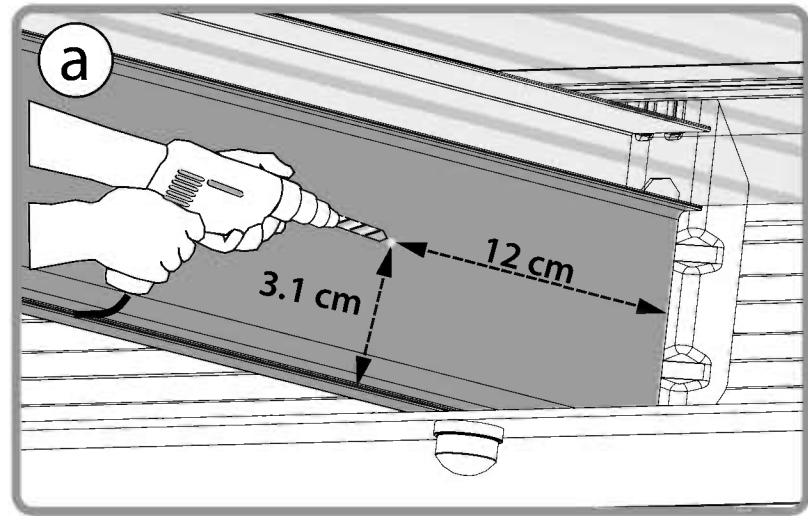
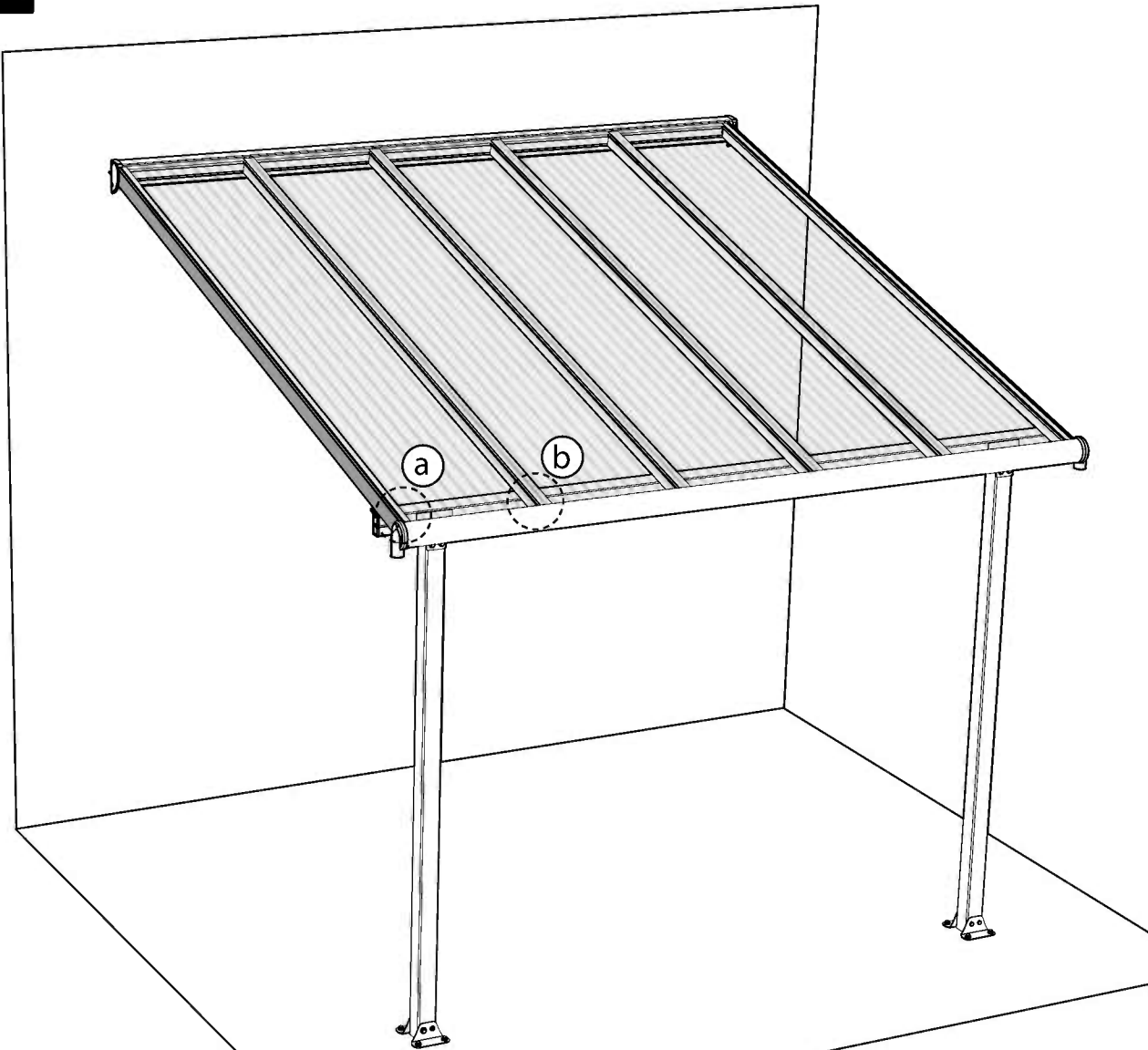

4mm
5/32"



3

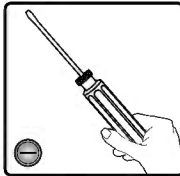
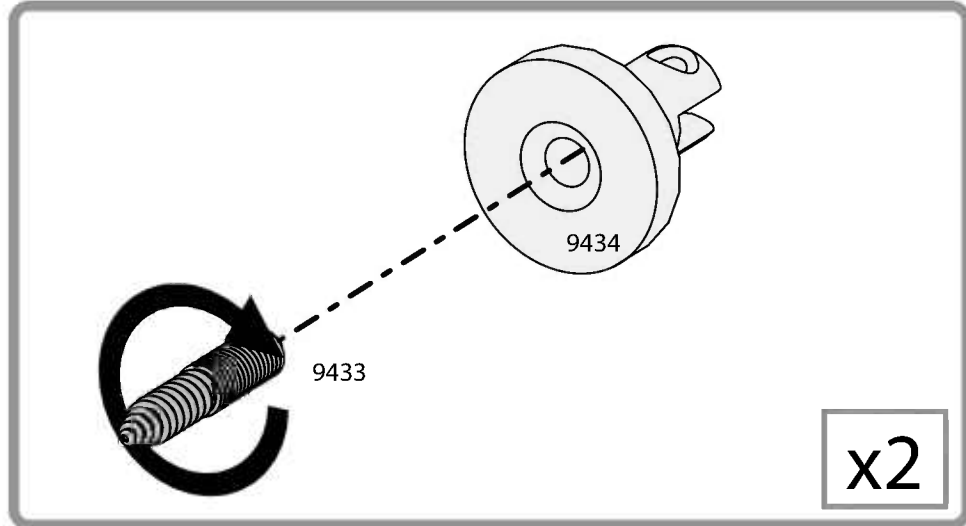
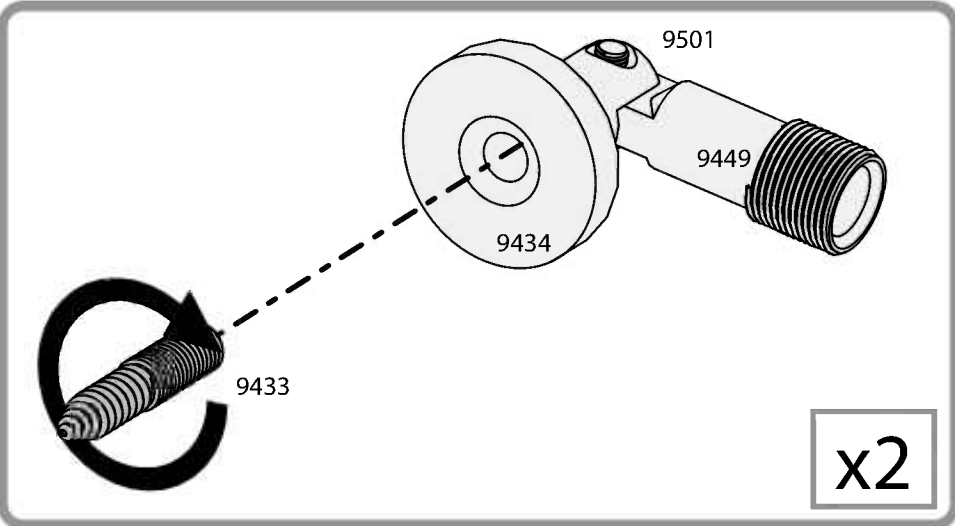
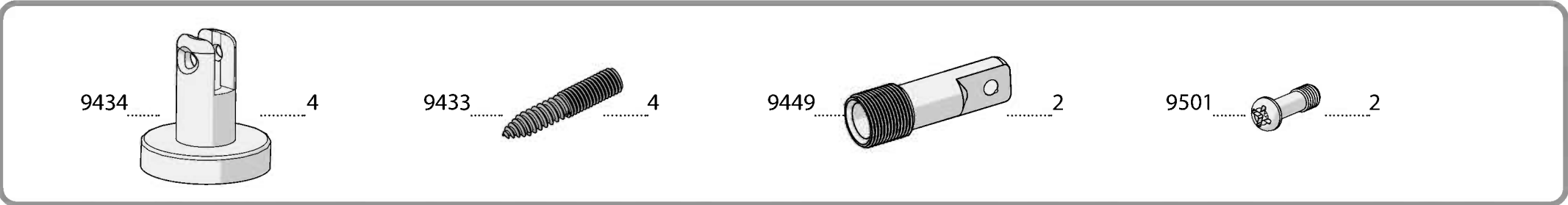

4

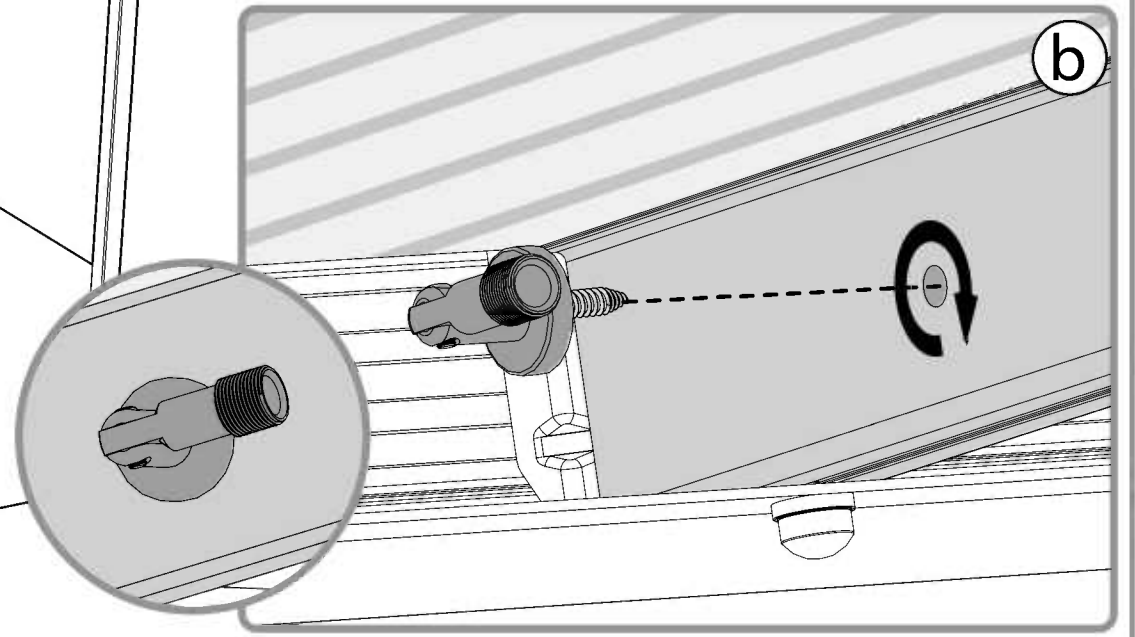
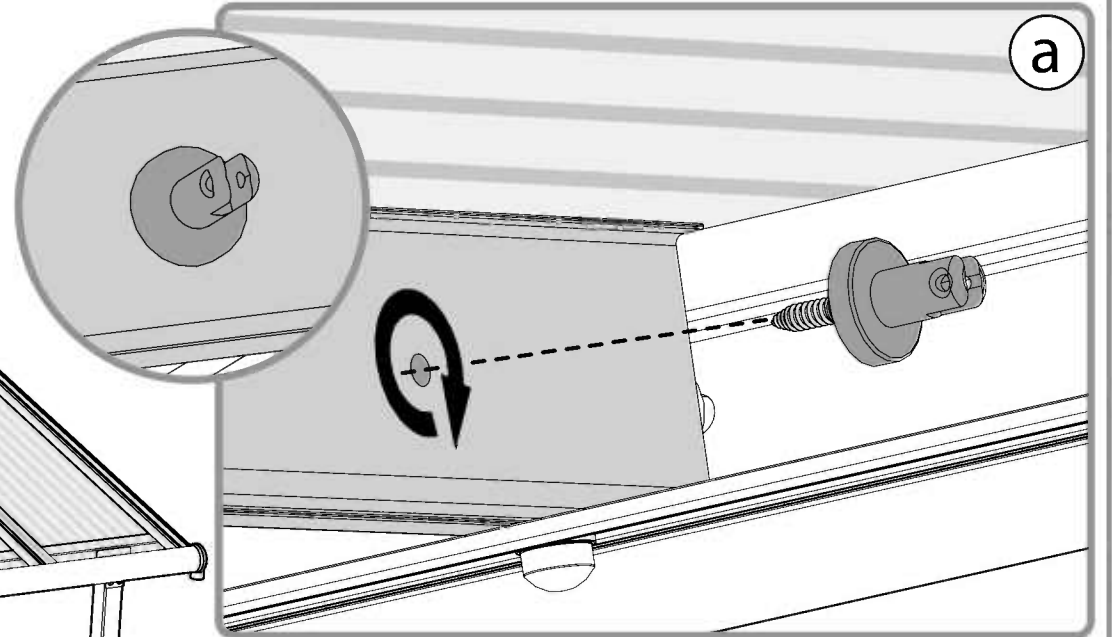
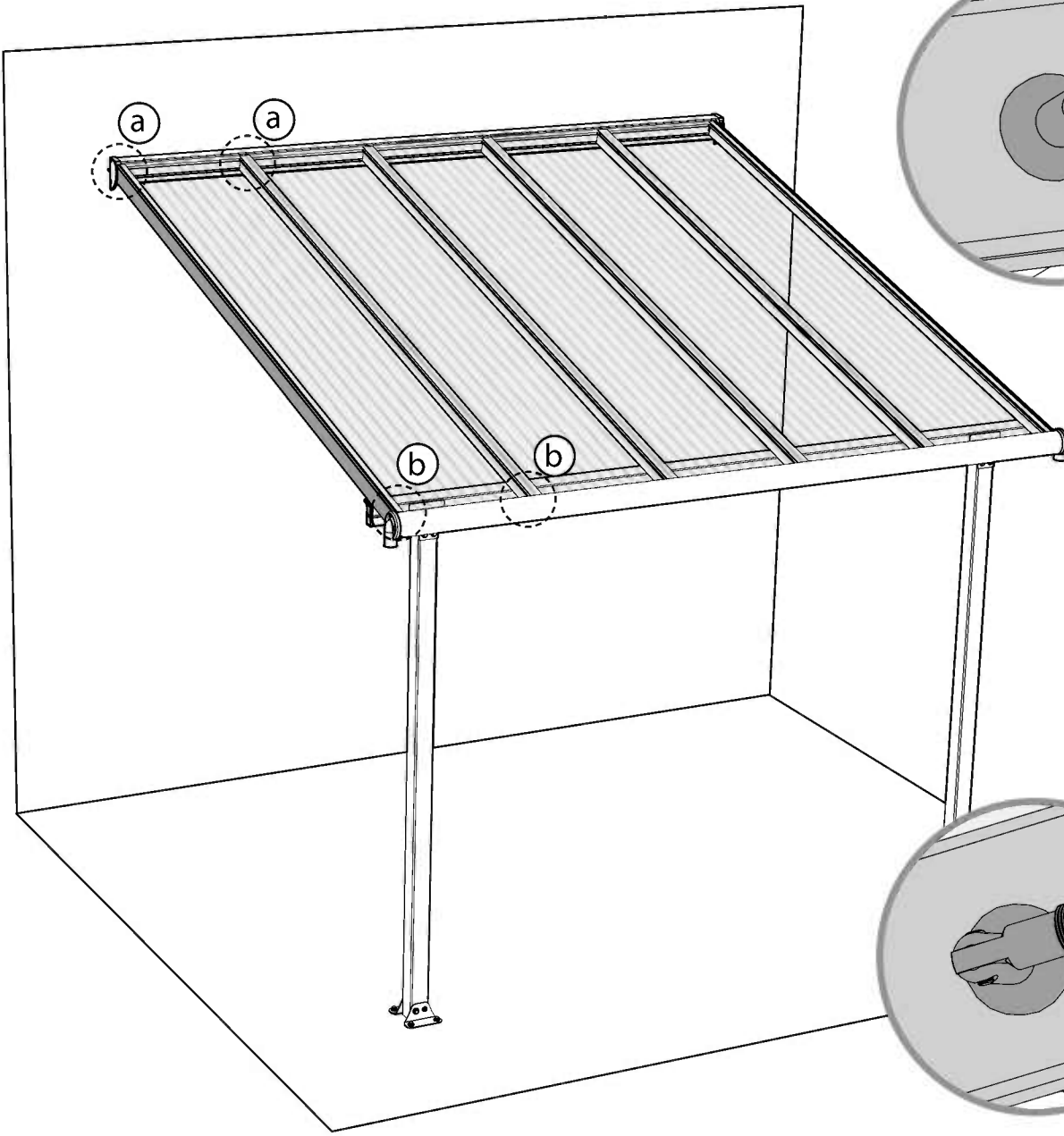

5

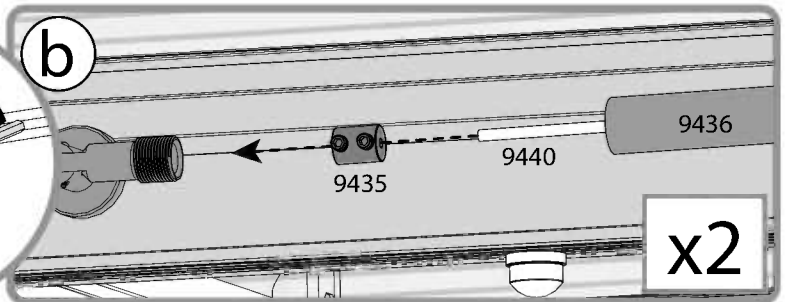
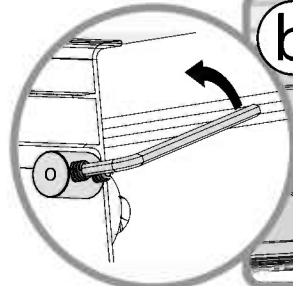
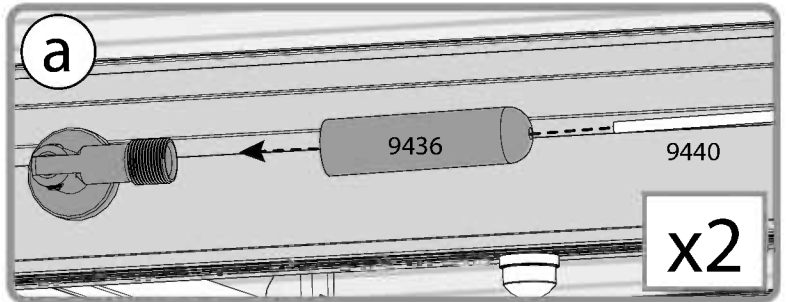
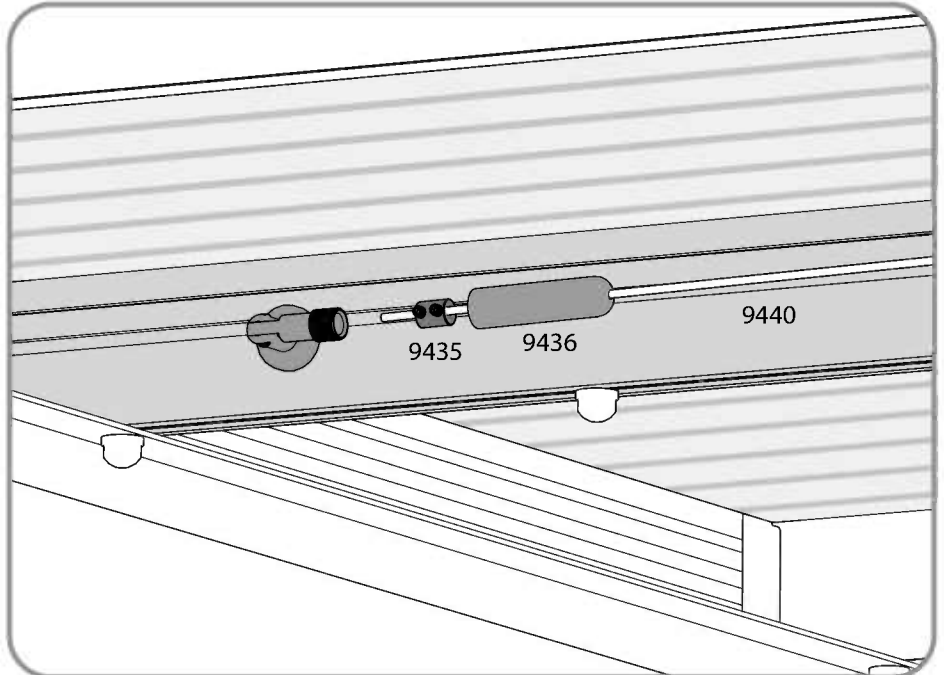
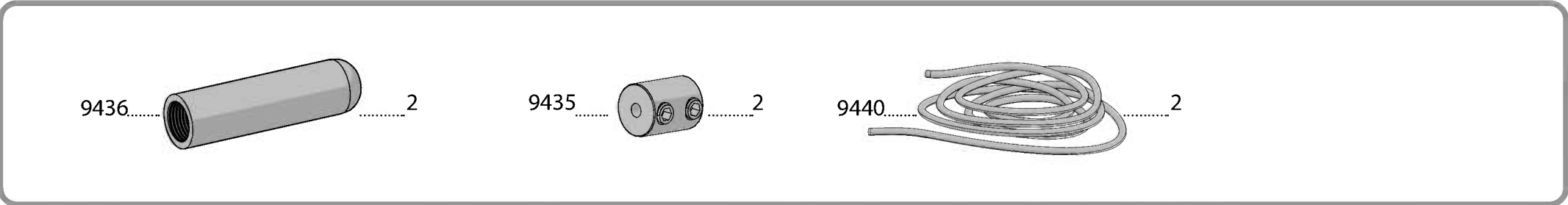

6



Turn the screw 3-4 times only, see drawing b.

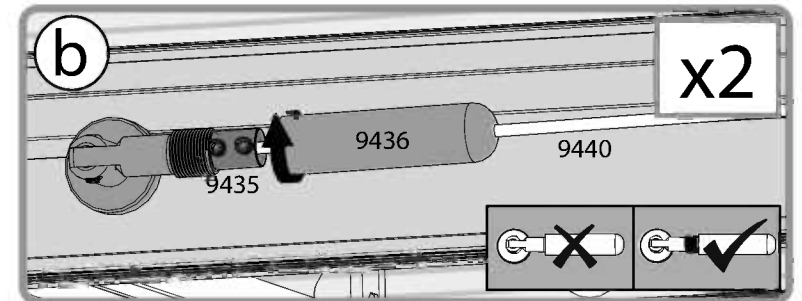
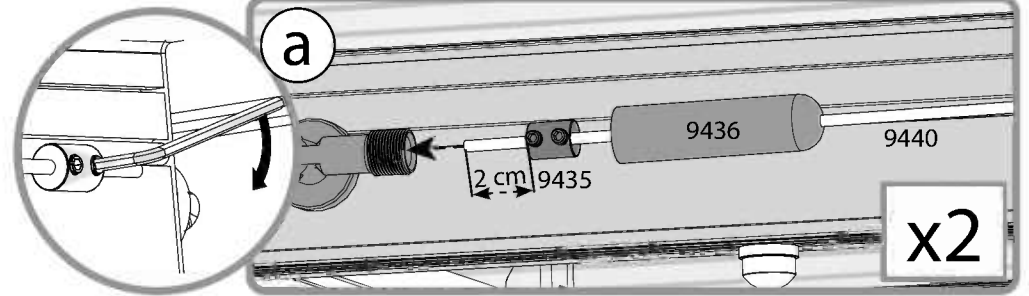
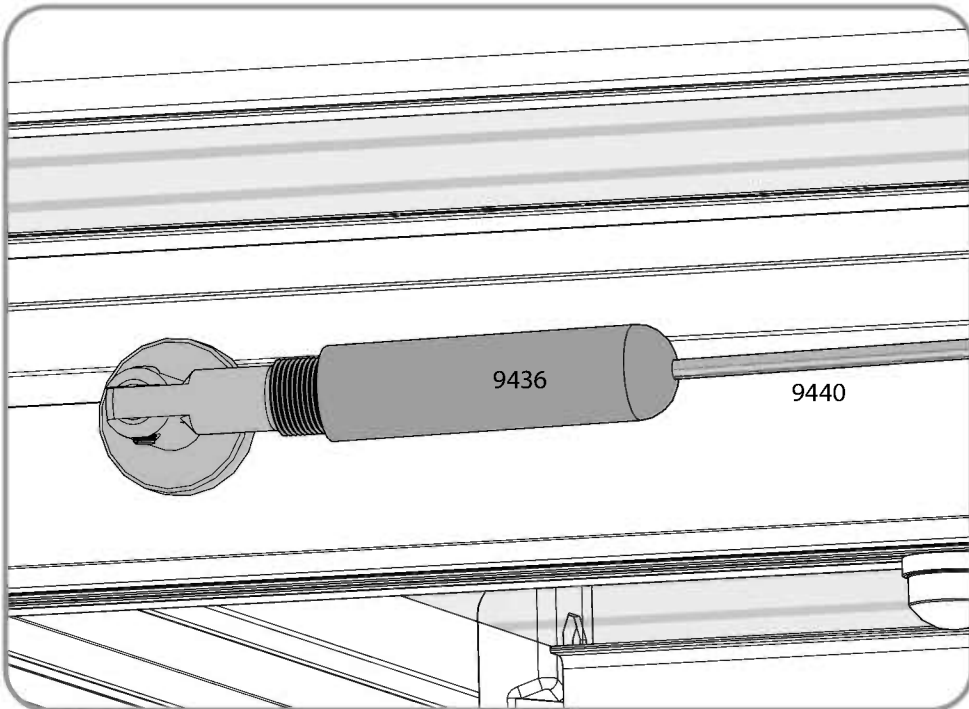
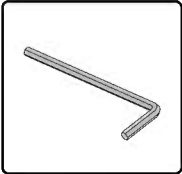

7

i Pull the cable while tightening and locking part #9435, see drawing c.

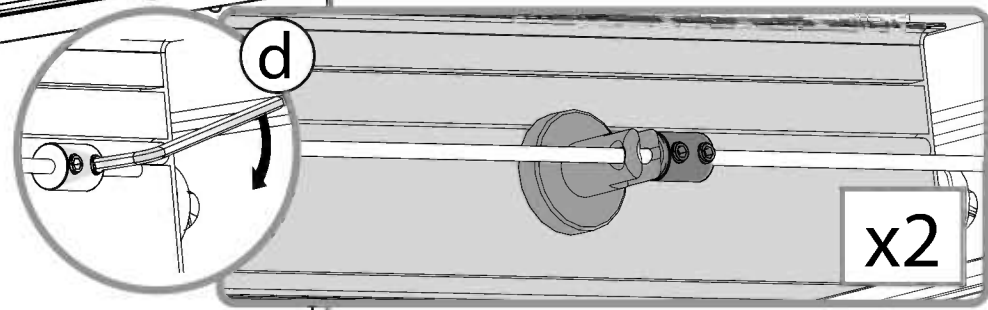
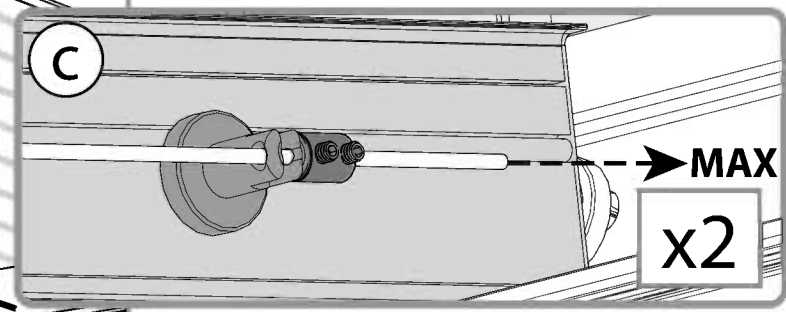
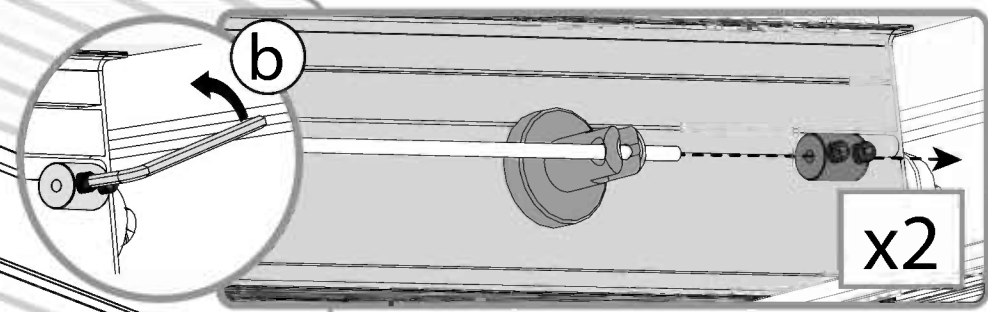
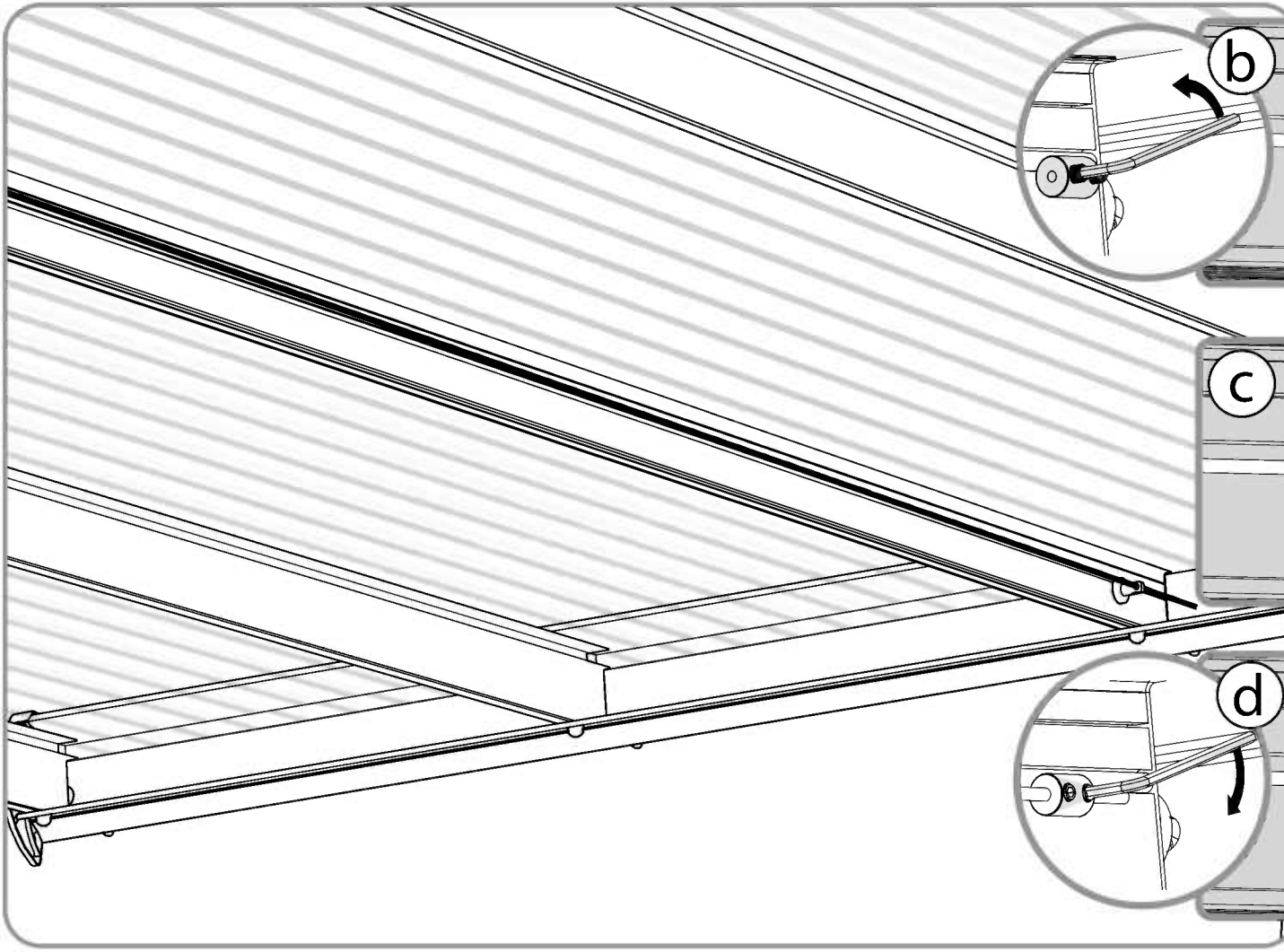
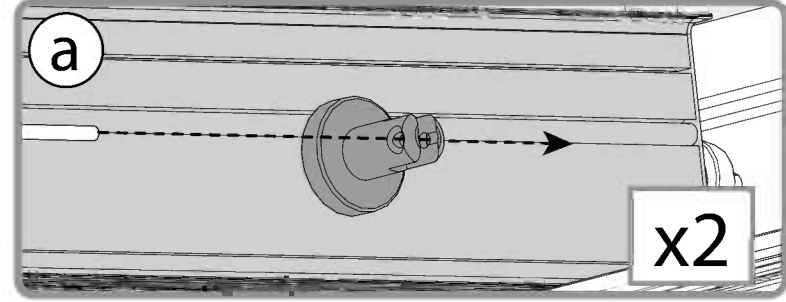
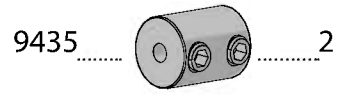
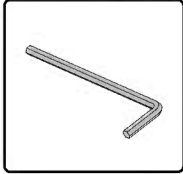

8

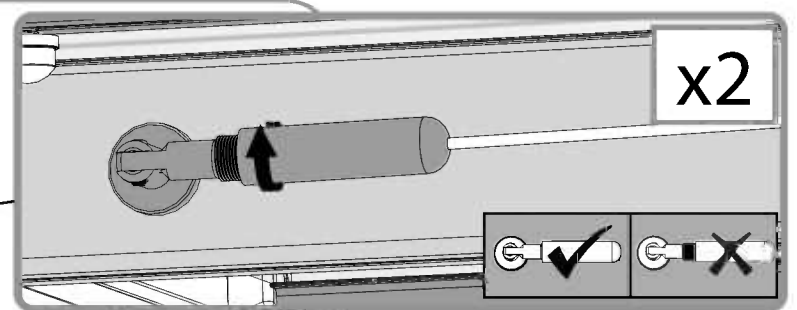
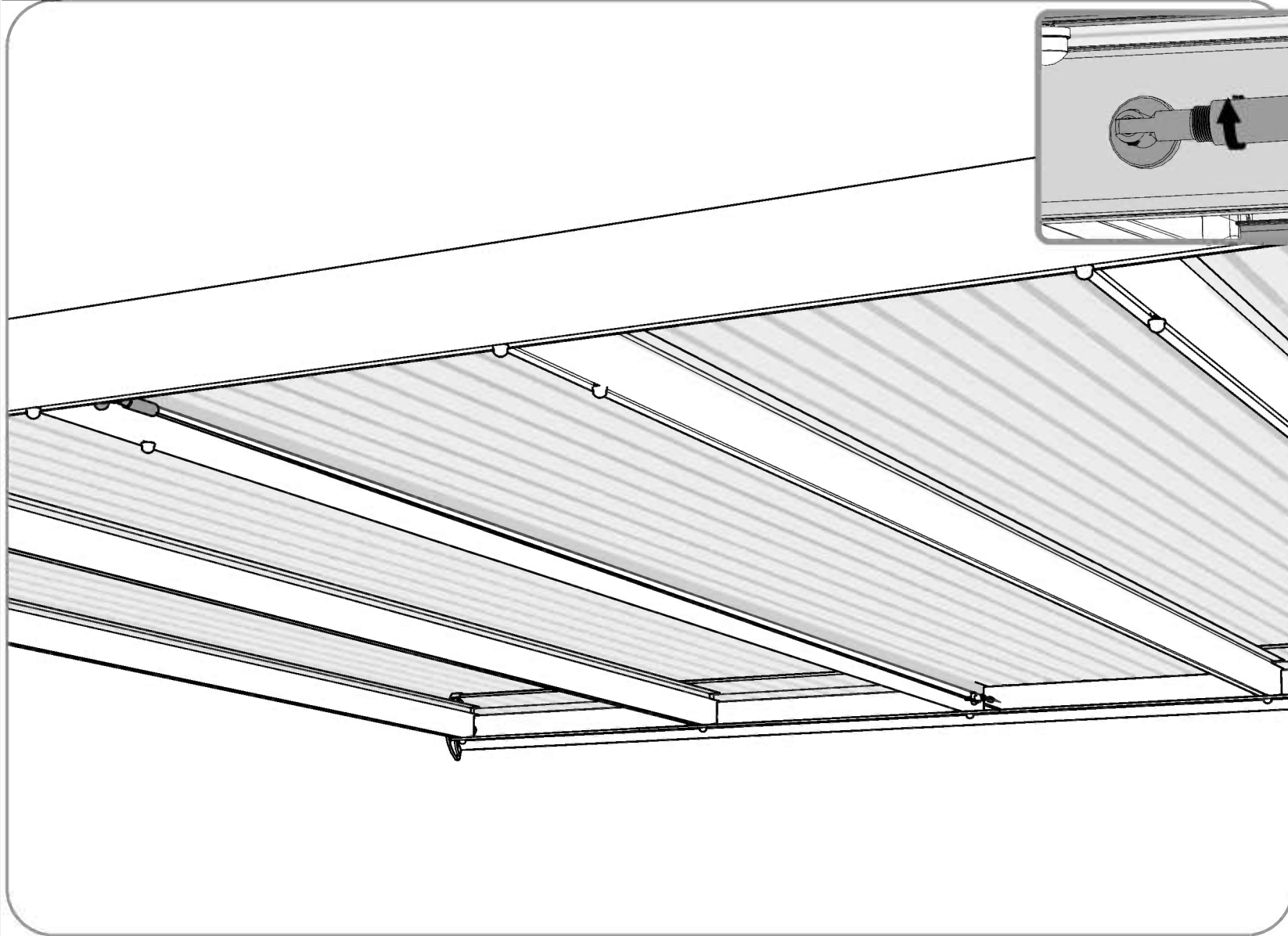

9

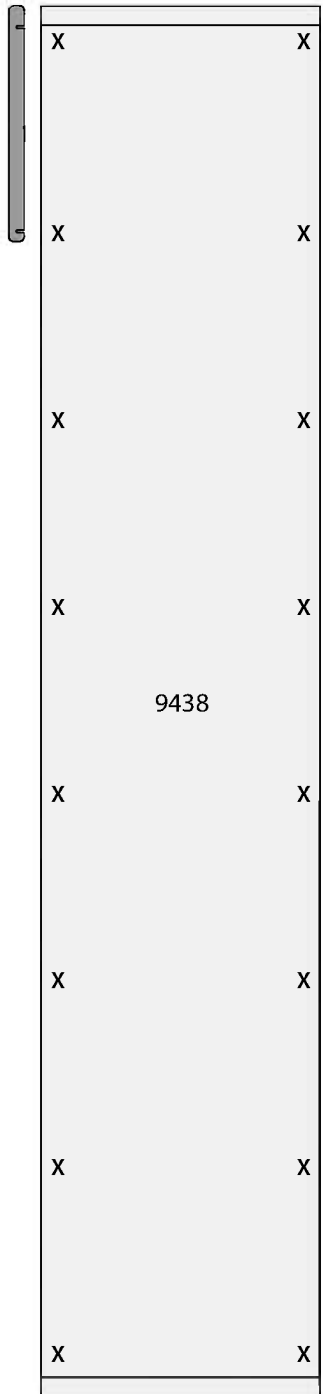
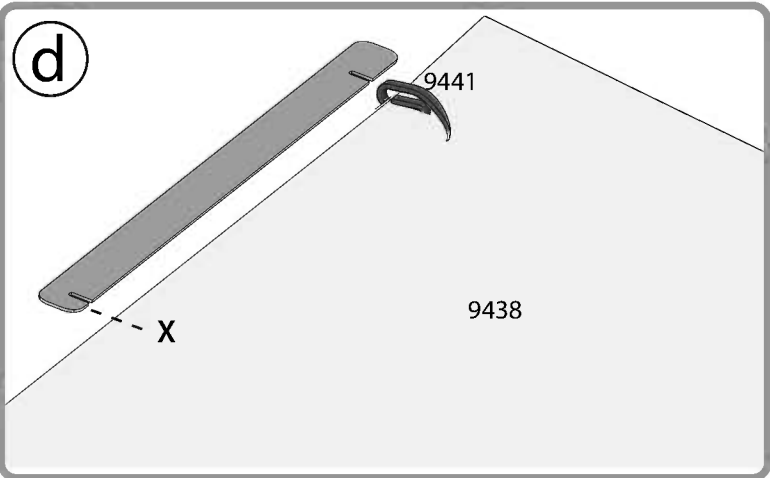
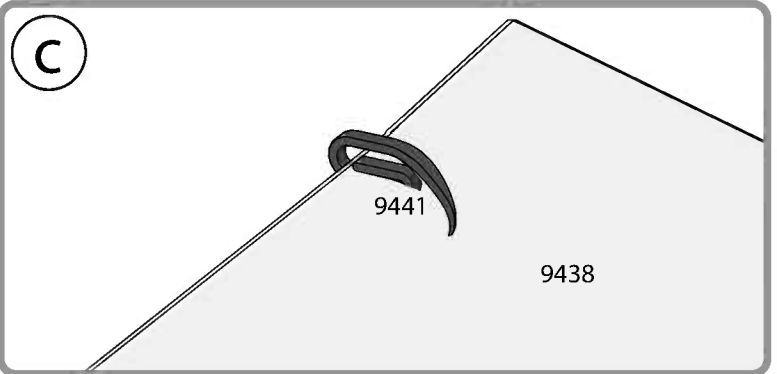
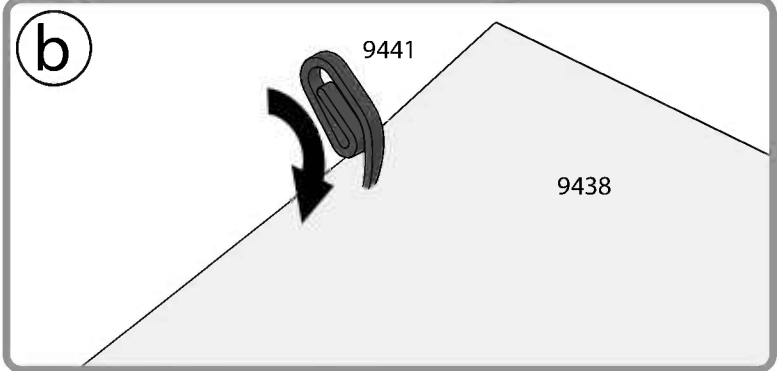
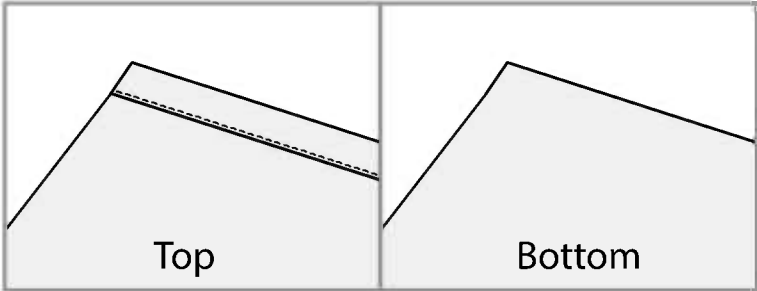
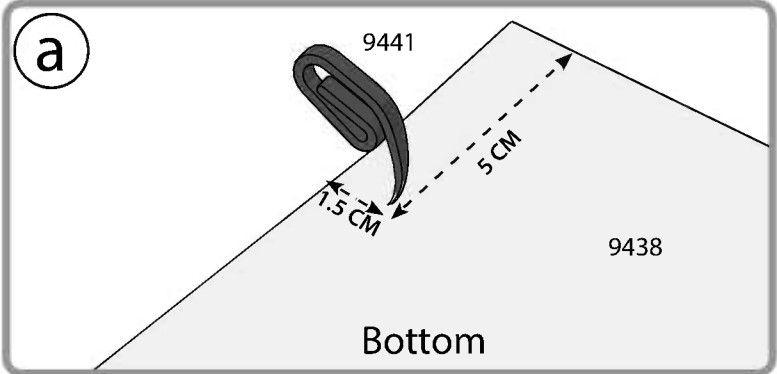
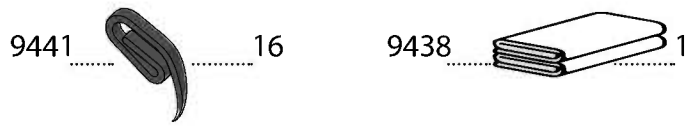

10

